

Ken-Tool®

*Proud to be your source for professional automotive
aftermarket tools & equipment for over 80 years.*

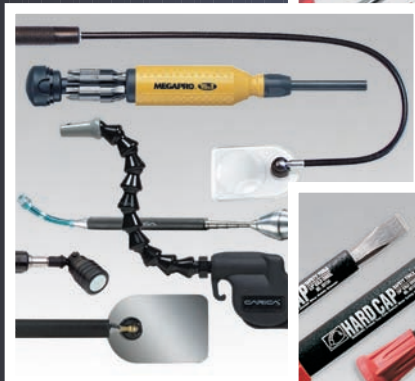
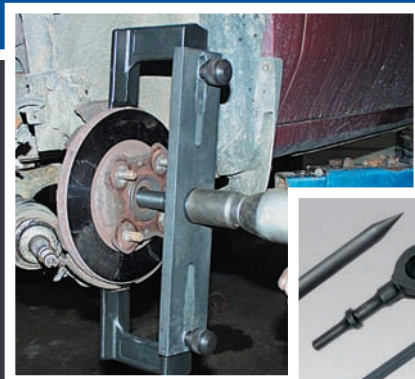

Hub-Shark®
Bearing & Rotor Pulling System

Oldforge®
Pneumatic Accessories & Specialty Tools

Carica™
Telescoping & Unique Specialty Tools

Hard Cap®
Chisels & Punches

Vises
Standard & Reversible Vises

Serpent™
Tire Changing Sets

Ken-Tool®
Tire Service Tools & Equipment

Hub-Shark®
 Hub-Shark 3

Oldforge®

A
 Aligning Bars 13

B
 Ball Joint Separator 6
 Body Tools:
 Awl 10
 Door Handle Tools 10
 Hook Tool 10
 Upholstery Clip Remover 10
 Brake Tools:
 Brake Adjusting Tools 11
 Brake Shoe Retaining Spring Tool 11
 Brake Spring Pliers 10
 Brake Spring Installing Tool 10
 Brake Spring Removal Tool 9
 Brake Spring Tool 11
 Brake Tool Set 11

C
 Chipping Hammer, Welder's 14
 Chisels, Pneumatic 5, 7, 8

E
 Exhaust System Tools:
 Muffler & Tailpipe Removers 8, 14
 Muffler & Tailpipe Chisels 4, 8

F
 File, Thread Restorer 14

H
 Hammers:
 Pneumatic 6, 7
 Welder's Chipping 14
 Headlight Adjusting Tool 14
 Hook Tool 10
 Hose Clamp Pliers 14

M
 Muffler Tools:
 Hand 14
 Pneumatic 4, 8

N
 Nut Splitter:
 Pneumatic 7

O
 Offset Screwdrivers 12

P
 Pliers:
 Brake 10
 Hose Clamp 14
 Pneumatic Tools:
 Body Service Tools 4
 Front End Tools 6, 7
 Heavy Duty Tools 7
 Muffler Tools 4
 Multi-Purpose Tools 5, 6
 Nut Splitting Tools 7
 Pneumatic Accessories 7
 Pneumatic Tool Sets 8
 Pry Bars:
 Close Quarters 13
 Die Setter 13
 Jimmy 13
 Pry Bars with Handles 13
 Roll Head 13
 Pullers:
 Stud remover 13
 Punches 12
 Punches, Pneumatic 5, 6, 7

R
 Radiator Hose Tool 14
 Retainer Spring 7

Retainer Chuck 7
 Rethreader Set 14
 Rivet Cutter, Pneumatic 7
 Roll Pin Punches 12

S
 Scrapers:
 5/8" Scraper 9
 Carbon Scraper 9
 Offset Scraper 9
 Extra Wide Carbon Scraper 9
 Pneumatic Scrapers 5
 Scaper Sets 9
 Stubby Scraper 9
 Screwdrivers:
 Offset Slotted Screwdrivers 12
 Super Long Screwdrivers 12
 Screw Extractors 12
 Seal Puller 14

T
 Thread Files, (Restorer) 14
 Tie Rod Separator 6
 Trim Remover 10

U
 Upholstery Clip Removers 10

V
 Valve Guide Remover & Installer 6

Carica™

A
 Air Blow Guns
 Interchangeable Air Blow Gun Set 15
 Pivoting Nylon 15
 Stainless Steel Telescoping 15

F
 Flexible Shaft Tools
 Magnets 19
 Magnifier 19
 Mirror 19

K
 Kits 18, 19

M
 Magnifiers
 Acrylic 17, 18, 19
 Magnifying Mirrors
 Tempered Glass 17

Magnets
 Flexible shaft 190
 Pen Tool w/Magnet 18
 Pick Set w/Magnet 18
 Pick-Up Tools 17, 19, 20

Mirrors
 Acrylic 18, 19
 Stainless Steel 17

P
 Pen Tools
 Pick-Up Magnet 18
 Pick-Up Magnet w/Swivel Mirror 18
 Pilot Light w/Alligator Clip 18
 Picks 16

S
 Specialty Screwdrivers 16
 Stethoscope 16

T
 Telescoping Tools
 Air Blow Guns 16
 Kits 18, 19
 Magnets 18, 19
 Magnifiers 17, 18, 19
 Mirrors 17, 18, 19
 Pen Tools 18
 Stethoscope 16

Hard Cap® Chisel & Punches
 Chisels 20, 21
 Punches 20, 21
 Chisel & Punch Sets 21

Vises & C-Clamps
 Pro Workshop Vises 22, 23
 Pro Reversible Mechanic's Vises 22, 23
 Professional C-Clamps 23

Serpent™ Tire Changing Sets
 Serpent™
 Mount & Demount Tools 24, 25
 Super Serpent™
 Mount & Demount Tools 26, 27

Ken-tool®

A
 Aluminum Wheel Protector 37

B
 Ball Joint Separator 45
 Bead Breakers
 ATV 41
 Driving Iron 34
 Floor Type 34
 Impact 34
 Portable 33
 Truck/Farm/OTR 33
 Wedges 38
 Bead Expanders, Pneumatic 42
 Bead Holding Device 25, 27, 37
 Bead Seaters 16

C
 Center Cap Removers
 Wide Blade 31
 Narrow Blade 31
 Chrome Lug Nut Cover Remover 42

D
 Dual Wheel Stud Remover 30

F
 Front End Tools
 Ball Joint Separator 45
 Pitman Arm Wedge 45
 Separator Tool 45
 Shock Link/Tie Rod Separator 45

H
 Hammers
 Cross-Pein/Blacksmith 38
 Dead Blow 38
 Epoxy Kits 39
 General Purpose 39
 Heavy-Duty 39
 New England Hand Drilling 38
 Rubber Mallet 38
 Sledge 38
 Handles
 Aluminum, Fiberglass, Wood 39

L
 Leak Locator 45
 Leverage Bar 29, 33
 Lock Ring Tools 34, 35
 Lubricant, Tire & Bead 45

M
 Manual Tire Changers for Small Tires 41

P
 Pitman Arm Wedge 45

R
 Rim Guard 43

S
 Separator Tool 45
 Shock Link/Tie Rod Separator 45

Sockets
 Flip Socket 42, 43
 Heavy-Duty Impact 42
 Socket Sets 43
 Spring Compressor
 MacPherson Strut 45
 Swab, Bead Lubricant 45

T
 Tire Changing Stand 40
 Tire Inflation Cages 40
 Tire Irons (Mount/Demount)
 European Style 36
 Heavy Duty/Truck 36, 37
 Motorcycle/Small Wheel 35
 Super Single 35
 Tire Snakes® 41
 Tubeless 36, 37
 Tire Knocker 38
 Tire Spoons
 Curved 36
 Drop-Center 36
 Straight 36
 Tire Spreaders 44
 Torque Master Torque Sticks 32, 33
 Truck Wrench Handle (Leverage Bar) 29

V
 Valve Repair Tools 45

W
 Wedges
 Bead Breaking 38
 Wheel Balancer 44
 Wheel Cover Puller/Replacers 31
 Wheel Lock Remover 42
 Wheel Lock Removal Kit 42
 Wheel Tools 44
 Wheel Weight Tools 44
 Wire Brush 44
 Wrenches
 4-Way Lug Wrenches
 Folding 46
 Heavy-Duty Truck 28
 Light Truck/SUV 28, 46
 OTR 28
 Passenger Car 28, 46
 Telescoping 46
 Cap Nut
 Combination 31
 Heavy-Duty 31
 Ken-Tool Porkchop™ 31
 Double-End Truck 29
 Power Wrench 30
 Shock Wrench 30
 Wrench Support Stand 29

NEW Look for this symbol beside individual product listings for exciting new tools from Ken-Tool

● Limited quantity
(Available until stock is depleted)

All weights and measurements are nominal. Variations in manufacturing may occur.

Ken-Tool®
 768 E. North St., P.O. Box 9320
 Akron, Ohio 44305
 Phone: 330-535-7177
 Fax: 330-535-1345
 Visit our web site at:
www.kentool.com

BEARING & ROTOR PULLING SYSTEM

SISTEMA DE TRACCIÓN DE ROTORES Y RODAMIENTOS

SYSTÈME D'EXTRACTION DE ROTORS & DE COUSSINETS



Includes everything you need to do the job.



Replace the front wheel bearings on front wheel drive vehicles without removing the steering knuckle from the vehicle - in about 20 minutes per wheel.

- Keep more jobs in house - don't send bearings out to be machine pressed
- Save time and money with reduced down time
- Pull and press any hub or bearing on domestic and import vehicles
- Pull inner bearing race from the hub
- Done completely on vehicle - no need to remove the knuckle assembly and re-align the front end
- Always be sure the center screw thread is clean and well lubricated
- Always wear safety goggles
- The Hub-Shark® is patented

Model No.	Description	Weight
7325	Hub-Shark System®	40 lbs (18.1 kg)

***7373 Adapter Kit:** The older version of the Hub-Shark®, before the current model 7325, could not pull hub with trapped or captive rotors. The 7373 consists only of larger hub puller and case from the 7325 set. This will modify older Hub-Sharks® and enable them to service trapped rotors.

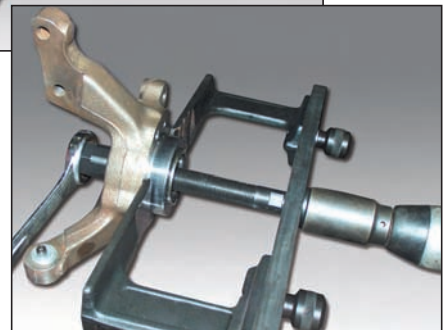
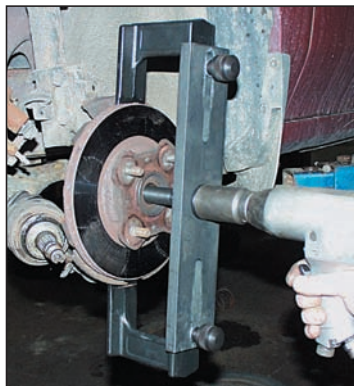
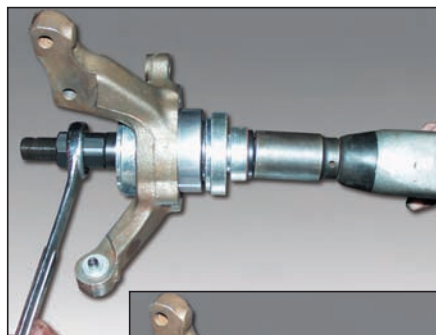

Pneumatic Tools • Herramientas neumáticas • Outils pneumatiques

Oldforge Pneumatic Tools are made in the United States and are finished in black oxide. PLEASE NOTE: THESE PNEUMATIC TOOLS ARE DESIGNED FOR USE WITH A .401 PARKER SHANK - EXCEPT THOSE PART NUMBERS WITH AN "H" PREFIX. HEAVY DUTY TOOLS HAVE .498 PARKER SHANKS.

Body Service Tools - Pneumatic (.401 shank)

Herramientas para mantenimiento de carrocería – Neumáticas (espiga de 0.401)

Outils de carrosserie – pneumatiques (tige .401)

Body Ripper



Cortadora de carrocería • Défonceuse de carrosserie

Tough as it's name, the body ripper is a favorite with body service technicians. Cuts a clean, short radius, virtually eliminating the added work of edging and welding. This tool has the exclusive Oldforge CURL-CUT™.

Model No.	Length	Stock	Weight
1955	6" (15.2 cm)	1/2" (13 mm)	.34 lbs (.15 kg)

Double-Cut Body Ripper



Cortadora de carrocería de doble corte

Défonceuse double de carrosserie

This tool has twice the life of a single cutting tool because it has two cutting edges on the body. Both cutting surfaces have the exclusive Oldforge CURL-CUT™.

Model No.	Length	Stock	Weight
1956	6-1/4" (15.7 cm)	1/2" (13 mm)	.34 lbs (.15 kg)

Panel Cutter



Cortador de panel • Coupoir de panneau

This is a tool designed for both straight and radius cuts on body and door panels. The cut curls away, making the precision you need easier to achieve. This tool has the exclusive Oldforge CURL-CUT™.

Model No.	Length	Stock	Weight
1957	6" (15.2 cm)	1/2" (13 mm)	.34 lbs (.15 kg)

Slotted Panel Cutter



Cortador de panel con ranuras • Coupoir de panneau fendu

This tool leaves a clean, smooth edge with the cut curling up through the slot in the middle. This tool has the exclusive Oldforge CURL-CUT™.

Model No.	Length	Stock	Weight
1958	6" (15.2 cm)	1/2" (13 mm)	.33 lbs (.15 kg)

Sheet Metal Trimmer



Cortador de planchas metálicas • Détoureuse de tôle

When you need to edge light sheet metal without stretch or distortion, use this sheet metal trimmer and eliminate much of the touch up grinding that is necessary with other trimmers. **This is not designed to be a panel cutter.** This tool has the exclusive Oldforge CURL-CUT™.

Model No.	Length	Stock	Weight
1959	6" (15.2 cm)	1/2" (13 mm)	.33 lbs (.15 kg)

Spot Weld Breaker



Cortador de soldadura por puntos

Nappe sommet de soudure par points

The ideal tool for cutting spot welds. It also works very well for cutting molding and rivets.

Model No.	Length	Stock	Weight
1960	6" (15.2 cm)	1/2" (13 mm)	.34 lbs (.15 kg)

Radius Cutter



Cortador de curvaturas • Coupoir de rayon

This is an exceptional tool because of its ability to cut a tight radius quickly and smoothly.

Model No.	Length	Stock	Weight
1961	6-1/4" (15.7 cm)	1/2" (13 mm)	.33 lbs (.15 kg)

Muffler Tools - Pneumatic (.401 shank)

Herramientas para silenciadores – Neumáticas (espiga de 0.401)

Outils pour silencieux – pneumatiques (tige .401)

Muffler and



Tailpipe Remover

Desmontador de caño de escape y silenciador

Dégageur de silencieux et de tuyaux d'échappement arrière

Designed to separate telescoped tubing without damage to the inner section. This tool has the exclusive Oldforge CURL-CUT™.

Model No.	Length	Stock	Weight
1965	8" (20.3 cm)	1/2" (13 mm)	.42 lbs (.2 kg)

Inside Muffler Cutter

Cortador de silenciador interno

Coupoir de

silencieux intérieur



The convex cutting edge design will cut the motor side off muffler. These jobs are easier and faster when you use the proper tool.

Model No.	Length	Stock	Weight
1966	8-1/4" (21 cm)	1/2" (13 mm)	.46 lbs (.21 kg)

Outside

Muffler Cutter



Cortador de silenciador externo • Coupoir de silencieux extérieur

The concave cutting edge design will cut exhaust side of muffler.

Model No.	Length	Stock	Weight
1967	8-1/4" (21 cm)	1/2" (13 mm)	.46 lbs (.21 kg)

Tailpipe

Cutoff Tool



Herramienta para cierre de caño de escape

Outil à tronçonner pour tuyaux d'échappement arrière

The sharp concave edge on the thin blade will cut off the tailpipe with ease.

Model No.	Length	Stock	Weight
1968	8-1/4" (21 cm)	1/2" (13 mm)	.46 lbs (.21 kg)

Combination

Muffler Cutter



Cortador de silenciador de combinación

Coupoir de silencieux combiné

This versatile tool can be used for either "inside" or "outside" muffler cuts. It often proves to be the best tool for many other ripping and cutting tasks, too.

Model No.	Length	Stock	Weight
1969	8-1/4" (21 cm)	1/2" (13 mm)	.44 lbs (.19 kg)

Multi-Purpose Tools - Pneumatic (.401 shank)

Herramientas de aplicación general - Neumáticas (espiga de 0.401)

Outils polyvalents - pneumatiques (tige .401)

Splitting Tool



Herramienta de separación • Outil de fendage

The bend of the blade allows this tool to slice through bushings, cylinder sleeves and muffler connections with ease. This tool has the exclusive Oldforge CURL-CUT™.

Model No.	Length	Stock	Weight
1971	8-1/4" (21 cm)	1/2" (13 mm)	.4 lbs (.18 kg)

Cold Chisels



Cortatríos • Ciseaux à froid

Designed to cut bolts, nuts, tees, angles and frame members. Blade width is 5/8".

Model No.	Length	Stock	Weight
1972	6-1/2" (16.5 cm)	1/2" (13 mm)	.35 lbs (.16 kg)
1973	8-1/2" (21.6 cm)	1/2" (13 mm)	.47 lbs (.21 kg)
1974	10-1/2" (26.7 cm)	1/2" (13 mm)	.58 lbs (.26 kg)
1986	18" (45.7 cm)	1/2" (13 mm)	1 lb (.5 kg)

Rivet and Bolt Cutter



Cortadores de pernos y remaches

Cisaille à rivets et coupe-boulons

Built with the "beef" and edge to cut rivets and bolts in bumpers, grilles, frames and brackets. Blade width is 5/8".

Model No.	Length	Stock	Weight
1975	6-1/2" (16.5 cm)	1/2" (13 mm)	.35 lbs (.16 kg)

Scraper



Raspador • Grattoir

Removes gaskets, rust, undercoating, paint, floor tile, plaster and roofcoatings with ease. The blade is offset for hand clearance. Blade width is 1-1/8".

Model No.	Length	Stock	Weight
1976	8" (20.3 cm)	1/2" (13 mm)	.46 lbs (.21 kg)

Wide Blade Scraper



Raspador de hoja ancha • Grattoir à large lame

Removes gaskets, rust, undercoating, paint, floor tile face area. Blade width is 2".

Model No.	Length	Stock	Weight
1970	8.5" (21.6 cm)	1/2" (13 mm)	.5 lbs (.2 kg)

Long Scraper • Raspador largo • Grattoir long



Designed to get in those hard-to-reach areas. Removes gaskets, rust, undercoating, and paint with ease. Blade width is 1-1/8".

Model No.	Length	Stock	Weight
2010	17-1/2" (44.4 cm)	1/2" (13 mm)	1 lb (.5 kg)

Sharp Point Long Taper Punch, Flat Tip

Punzón cónico largo de punta afilada y plana

Chasse-cônes longs aigus



Use for peening and crimping bodies, driving smaller rivets and hinge pins.

Model No.	Length	Stock	Weight
2012	18" (45.7 cm)	1/2" (13 mm)	1 lb (.5 kg)

Oldforge®

PNEUMATIC ACCESSORIES & SPECIALTY TOOLS

ACCESORIOS NEUMÁTICOS Y HERRAMIENTAS ESPECIALIZADAS ACCESSOIRES PNEUMATIQUES ET OUTILS SPÉCIAUX

Tools That Make Your Job Easier...

PNEUMATIC TOOLS

BODY TOOLS

BRAKE TOOLS

SCREWDRIVERS

SCREW EXTRACTORS

ALIGNING & PRY BARS

SCRAPERS

SPECIALTY PURPOSE TOOLS

*American made hand tools for
professionals world wide since 1925*

**Sharp Point
Taper Punches**



Punzones cónicos de punta afilada • Chasse-cônes aigus

Punch holes in sheet metal for entrance of screws or wires.

Model No.	Length	Stock	Weight
1977	6-1/2" (16.5 cm)	1/2" (13 mm)	.35 lbs (.16 kg)
1978	18" (45.7 cm)	1/2" (13 mm)	1 lb (.5 kg)

Taper Punch • Punzones cónicos • Chasse-cônes



Use for peening and crimping bodies, driving rivets and hinge pins. 3/8" tip.

Model No.	Length	Stock	Weight
1979	6" (15.2 cm)	1/2" (13 mm)	.35 lbs (.16 kg)

Straight Punch • Punzón recto • Poinçon droit



Use for peening and crimping bodies, driving rivets and hinge pins. 1/2" tip.

Model No.	Length	Stock	Weight
1980	6" (15.2 cm)	1/2" (13 mm)	.35 lbs (.16 kg)

Long Taper Punch

Punzones cónicos largo • Chasse-cône longs



Extra long body for driving rivets and hinge pins. 3/8" tip.

Model No.	Length	Stock	Weight
2011	18" (45.7 cm)	1/2" (13 mm)	1 lb (.5 kg)

Long Pneumatic Tool Set

Equipo de herramientas neumáticas largas

Jeu d'outils pneumatiques longs

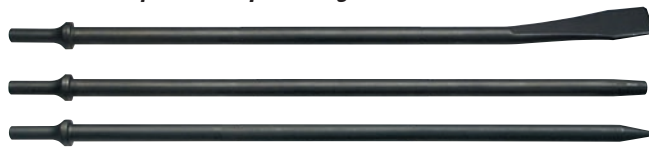

Extra long body for those hard-to-reach areas.

Set consists of: No. 2010 Long Scraper
No. 2011 Long Taper Punch
No. 2012 Sharp Point Long Taper Punch, Flat Tip

Model No.	Description	Weight
7323	3 Pc. Set	2.9 lbs (1.3 kg)

Hammer • Martillo • Marteau



Excellent for hammering operations such as U-joints, ball joint and body forming work.

Model No.	Length	Stock	Head Dia.	Weight
1981	3-1/2" (8.9 cm)	1/2" (13 mm)	1"	.31 lbs (.14 kg)
1982	4" (10.2 cm)	1/2" (13 mm)	1"	.35 lbs (.16 kg)

Long Hammer • Martillo largo • Marteau long

Used in hard-to-reach areas. Excellent for hammering operations such as U-joints, ball joint and body forming work.



Model No.	Length	Stock	Head Dia.	Weight
1987	6" (15.2 cm)	1/2" (13 mm)	1"	.44 lbs (.19 kg)

**Valve Guide
Remover/Installer**



Instalador/removedor de guía de válvula

Dispositif d'extraction/d'installation de guide de soupape

Pneumatic valve guide drivers are used to remove and install replaceable valve guides. They can be used on most passenger cars and light trucks that have aluminum heads or cast iron heads which have replaceable valve guides.

Model No.	Length	Stock	Pilot	Weight
2006	6" (15.2 cm)	1/2" (13 mm)	8 mm	.3 lbs (.14 kg)

Front End Tools - Pneumatic (.401 shank)

Herramientas delanteras - Neumáticas

(espiga de 0.401)

Outils de train avant - pneumatiques (tige .401)

Idler Arm Bushing Cutter

Cortador de casquillos del brazo secundario libre

Coupoir de fourrure du bras de renvoi

This tool was designed with higher cutting angles to cut the bushing from the idler arm. It also works well as a panel cutter.



Model No.	Length	Stock	Weight
1990	6" (15.2 cm)	1/2" (13 mm)	.34 lbs (.15 kg)

**Control Arm
Bushing Remover**



Desmontador de casquillos del brazo oscilante

Dégageur de fourrure du bras de suspension

The concave design will hold the contacting edge against the bushing.

Model No.	Length	Stock	Weight
1991	6" (15.2 cm)	1/2" (13 mm)	.33 lbs (.15 kg)

Tie Rod Sleeve Breaker



Desmontadora de eje de la barra del acoplamiento

Linguet de manchon de biellette de direction

The vibration of this tool against the tie rod assembly will break rust and corrosion to permit easy adjustment.

Model No.	Length	Stock	Weight
1993	4" (10.2 cm)	1/2" (13 mm)	.28 lbs (.13 kg)

Tie Rod Separator



Separador de la barra del acoplamiento

Séparateur de manchon de biellette de direction

The specific opening between tines of 21/32" does the job quickly and properly.

Model No.	Length	Fork Opening	Weight
1995	8" (20.3 cm)	21/32" (17 mm)	.77 lbs (.35 kg)

Ball Joint Separator



Separador de juntas de rótulas

Séparateur de joint à rotule

The opening between tines is 15/16", which will handle ball joints with a minimum of shock to the assembly.

Model No.	Length	Fork Opening	Weight
1996	8" (20.3 cm)	15/16" (24 mm)	.74 lbs (.34 kg)

Taper Punch

Punzón cónico • Chasse-cône

The 1/8" diameter point will drive out pins and rivets.



Model No.	Length	Stock	Weight
1997	6-1/2" (16.5 cm)	1/2" (13 mm)	.34 lbs (.15 kg)

Shock Absorber Chisel

Cinzel para amortiguador

Ciseau à amortisseurs

The two-step design of this chisel gives you two cutting edges for easy removal of shock absorber nuts.



Model No.	Length	Stock	Weight
1998	6-1/2" (16.5 cm)	1/2" (13 mm)	.34 lbs (.15 kg)

Heavy-Duty Pneumatic Tools (.498 shank)

Herramientas neumáticas de alta resistencia (espiga de 0.498)

Outils pneumatiques robustes (tige .498)

These heavy-duty tools are similar to their counterparts, **No. 1972, No. 1975, No. 1981, and No. 1997**, but they are constructed for heavy-duty use with the .498 Parker shank.

Tapered Punch with 3/16" Point

Punzón cónico con punta de 3/16 de pulgada

Chasse-cône, pointe 3/16 po

The 3/16" diameter point will drive out pins and rivets.



Model No.	Length	Stock	Weight
H-1997	8" (20.3 cm)	5/8" (16 mm)	.61 lbs (.28 kg)

6" Cold Chisel

Cortafíos de 6 pulgadas • Ciseau à froid, 6 po

Designed to cut bolts, nuts, tees, angles and frame members. Blade width is 13/16".



Model No.	Length	Stock	Weight
H-1972	7-1/2" (19.1 cm)	5/8" (16 mm)	.61 lbs (.28 kg)

Rivet and Bolt Cutter

Cortadores de pernos y remaches

Cisaille à rivets et coupe-boulons

Built with the "beef" and edge to cut rivets and bolts in bumpers, grilles, frames and brackets. Blade width is 13/16".



Model No.	Length	Stock	Weight
H-1975	7-1/2" (19.1 cm)	5/8" (16 mm)	.62 lbs (.28 kg)

1-1/4" Diameter Hammer

Martillo de 1 1/4 pulgada de diámetro

Marteau 1-1/4 po de diámetro

Excellent for hammering operations such as U-joints, ball joint and body forming work.



Model No.	Length	Stock	Weight
H-1981	4" (10.2 cm)	5/8" (16 mm)	.53 lbs (.24 kg)

Nut Splitting Tools - Pneumatic (.401 shank)

Herramientas separadoras de tuercas - Neumáticas (espiga de 0.401)

Casse-écrous - pneumatiques (tige .401)



6" nut splitter will remove locking clamps on tie rods, the exhaust flange on 6 cylinder engines and top or bottom nuts on foreign and domestic shocks.

Model No.	Length	Opening	Weight
1983	6" (15.2 cm)	5/16" (.8 cm)	.34 lbs (.15 kg)

10" nut splitter can be used to remove the top nuts on shock absorbers and V-8 exhaust flanges.

Model No.	Length	Opening	Weight
1984	10" (25.4 cm)	3/8" (1 cm)	.57 lbs (.26 kg)

18" nut splitter provides the extra reach needed to work around air conditioner parts.

Model No.	Length	Opening	Weight
1985	18" (45.7 cm)	3/8" (1 cm)	1 lb (.5 kg)

Pneumatic Accessories

Accesorios neumáticos • Accessoires pneumatiques

Retainer Spring

Anillo de retención • Ressort-arrêtoir

This retainer spring fits .401 diameter shank pneumatic tools. Reduces the risk of accidental shank release. The retainer spring grips the shank tighter as hammering force increases, but lets you snap tools in and out easily.



Model No.	Weight
1988	.14 lbs (.06 kg)

Retainer Chuck

Plato de retención

Raccord de gonflage-arrêtoir

This improved pneumatic tool holder locks the tool firmly into place. Tools can be changed quickly. At the first sign of cracking or distortion of the chuck, it should be discarded.



Model No.	Weight
2053	.16 lbs (.07 kg)

Pneumatic Tool Sets (.401 shank)
Equipos de herramientas neumáticas
(espiga de 0.401)

Jeux d'outils pneumatiques (tige .401)

Popular tool assortments in reusable storage pouches:

Four Piece Body Pneumatic Set
Juego neumático para el chasis de
cuatro piezas

Ensemble pneumatique central quatre
pièces

Set consists of:

- No. 1958 Panel Cutter
- No. 1976 Scraper
- No. 1972 Cold Chisel
- No. 1982 Hammer

Model No.	Description	Weight
7318	4 Pc. Set	1.6 lbs (.7 kg)



Four Piece Front End Pneumatic Set
Juego neumático delantero de cuatro
piezas

Ensemble pneumatique extrémité
avant quatre pièces

Set consists of:

- No. 1982 Hammer
- No. 1995 Tie Rod Separator
- No. 1996 Ball Joint Separator
- No. 1997 Taper Punch

Model No.	Description	Weight
7319	4 Pc. Set	2.5 lbs (1.1 kg)



Four Piece Basic Pneumatic Tool Set
Equipo de herramientas neumáticas
básicas de cuatro piezas

Jeux d'outils pneumatiques de base de
quatre pièces

Here is a basic set of pneumatic tools to handle the most common problems encountered in the typical shop. This is a good "starter" set. Packaged in a leatherette pouch.

Set consists of:

- No. 1965 Muffler-Tailpipe Remover
- No. 1971 Splitting Tool
- No. 1972 6" Cold Chisel
- No. 1975 Rivet and Bolt Cutter

Model No.	Description	Weight
7320	4 Pc. Set	1.5 lbs (.7 kg)



Four Piece Muffler-Tailpipe Pneumatic Tool Set
Equipo de herramientas neumáticas para caños de
escape/silenciadores de cuatro piezas
Jeux d'outils pneumatiques pour silencieux
et tuyaux d'échappement arrière de
quatre pièces

The pneumatic tools needed for muffler-tailpipe work. These specially designed tools will help you do the job quickly and correctly. Packaged in a leatherette pouch.

Set consists of:

- No. 1965 Muffler-Tailpipe Remover
- No. 1966 "Inside" Muffler Cutter
- No. 1967 "Outside" Muffler Cutter
- No. 1968 Tailpipe Cutoff Tool

Model No.	Description	Weight
7321	4 Pc. Set	1.7 lbs (.8 kg)



Nine Piece Professional Technician Pneumatic Tool Set
Equipo de herramientas neumáticas para técnicos
profesionales de nueve piezas
Jeux d'outils pneumatiques pour techniciens professionnels
de neuf pièces

A complete assortment of pneumatic tools to handle many different problems encountered by the technician. Packaged in a leatherette pouch.

Set consists of:

- No. 1955 Body Ripper
- No. 1957 Panel Cutter
- No. 1958 Slotted Style Panel Cutter
- No. 1959 Sheet Metal Trimmer
- No. 1965 Muffler-Tailpipe Remover
- No. 1971 Splitting Tool
- No. 1972 6" Cold Chisel
- No. 1975 Rivet and Bolt Cutter
- No. 1997 Taper Punch with 1/8" Point

Model No.	Description	Weight
7322	9 Pc. Set	3.1 lbs (1.4 kg)



Eighteen Piece Pneumatic Block Display
Presentación de bloque neumático de dieciocho piezas
Étalage du bloc pneumatique de dix-huit pièces

All the tools you will need to have a complete pneumatic tool set. Ideal for all the different jobs in the shop.

Set consists of:

- | | | | | |
|----------|----------|----------|----------|----------|
| No. 1956 | No. 1965 | No. 1974 | No. 1979 | No. 1996 |
| No. 1958 | No. 1968 | No. 1975 | No. 1980 | No. 1997 |
| No. 1959 | No. 1972 | No. 1976 | No. 1982 | |
| No. 1960 | No. 1973 | No. 1977 | No. 1995 | |

Model No.	Description	Weight
7394	Block Display	8 lbs (3.6 kg)

Scrapers • Raspador • Grattoirs coudé

Oldforge scrapers are made from forged alloy heat-treated steel and will not warp or bend under normal use. Blades are precision ground for sharp edges and can be sharpened again and again. The finish is a durable black oxide with sturdy, durable polymer handles.

Offset Scraper



Raspador de compensación

The Oldforge offset scraper will quickly clean gaskets and carbon from intake manifolds, water pumps and other hard to reach surfaces.

Model No.	Blade Width	Length	Weight
7241	5/8" (1.6 cm)	8-1/4" (21 cm)	.26 lbs (.12 kg)

1/4" Scraper



Raspador de 1/4 pulgadas • Grattoir 1/4 po

Model No.	Blade Width	Length	Weight
7242	1/4" (.63 cm)	12" (30.4 cm)	.35 lbs (.15 kg)

5/8" Scraper



Raspador de 5/8 pulgadas • Grattoir 5/8 po

This Oldforge scraper is specially designed to clean gaskets from oil pan surfaces for engines and/or transmissions.

Model No.	Blade Width	Length	Weight
7243	5/8" (1.6 cm)	7" (17.8 cm)	.24 lbs (.11 kg)

1/2" Scraper



Raspador de 1/2 pulgadas • Grattoir 1/2 po

Model No.	Blade Width	Length	Weight
7244	1/2" (1.2 cm)	12" (30.4 cm)	.35 lbs (.15 kg)

Stubby Scraper



Raspador de mango ancho • Grattoir tronqué

The Oldforge stubby scraper will make it easier for the technician to complete scraping operations on those tight, almost hidden surfaces.

Model No.	Blade Width	Length	Weight
7245	1" (2.5 cm)	7" (17.8 cm)	.23 lbs (.1 kg)

1" Scraper



Raspador de 1 pulgada • Grattoir 1 po

Model No.	Blade Width	Length	Weight
7246	1" (2.5 cm)	12" (30.4 cm)	.35 lbs (.15 kg)

3/4" Scraper



Raspador de 3/4 pulgadas • Grattoir 3/4 po

Model No.	Blade Width	Length	Weight
7248	3/4" (1.9 cm)	12" (30.4 cm)	.35 lbs (.15 kg)

Carbon Scraper



Raspador de hollín • Grattoir de carbone

Model No.	Blade Width	Length	Weight
7039	1" (2.5 cm)	9-3/4" (24.8 cm)	.29 lbs (.13 kg)

Extra Wide Carbon Scraper



Raspador de hollín extra ancho • Grattoir de carbone ultra large

Model No.	Blade Width	Length	Weight
7040	1-1/2" (3.8 cm)	13" (33 cm)	.64 lbs (.29 kg)

Scraper Sets

Equipos de raspadores • Jeux de grattoirs

These scraper sets were requested by automotive technicians in the field who have first hand knowledge of the assorted sizes and shapes necessary to accomplish varied scraping tasks. These are the scraper sets you will be glad you added to your tool box. Made from forged alloy heat-treated steel, they will not warp or bend under normal use. Blades are precision ground for sharp edges and can be sharpened again and again. The finish is a durable black oxide with sturdy, durable plastic handles. The scraper sets are packed in impact resistant plastic trays.



Two Piece Scraper Set

Equipo de raspadores de dos piezas Jeu de grattoirs de deux pièces

Set consists of: No. 7039 1" Carbon Scraper
No. 7040 1-1/2" Extra Wide Carbon Scraper

Model No.	Description	Weight
7434	2 Pc. Set	.93 lbs (.42 kg)

Four Piece Scraper Set

Equipo de raspadores de cuatro piezas Jeu de grattoirs de quatre pièces

Set consists of: No. 7039 1" Carbon Scraper
No. 7241 5/8" Offset Scraper
No. 7243 5/8" Scraper
No. 7245 1" Stubby Scraper

Model No.	Description	Weight
7365	4 Pc. Set	1.1 lbs (.5 kg)



Four Piece Scraper Set

Equipo de raspadores de cuatro piezas Jeu de grattoirs de quatre pièces

Set consists of: No. 7242 1/4" Scraper
No. 7244 1/2" Scraper
No. 7245 1" Stubby Scraper
No. 7246 1" Scraper

Model No.	Description	Weight
7504	4 Pc. Set	1.1 lbs (.5 kg)

Five Piece Scraper Set

Equipo de raspadores de cinco piezas Jeu de grattoirs de cinq pièces

Set consists of: No. 7241 5/8" Offset Scraper
No. 7243 5/8" Scraper
No. 7245 1" Stubby Scraper
No. 7246 1" Scraper
No. 7248 3/4" Scraper

Model No.	Description	Weight
7505	5 Pc. Set	1.1 lbs (.5 kg)



Body Tools

Herramientas para carrocería • Outils de carrosserie

Upholstery Clip Remover

Desmontador de grapas de tapizado

Dégageur d'attaches de garnissage



Quickly removes the upholstery clip from the car door. It fits many different sized clips, including the larger ones. The handle is sturdy, fluted plastic and the finish is black oxide.

Model No.	Length	Weight
1001	8" (20.3 cm)	.33 lbs (.15 kg)



Removes the upholstery clip. Specifically designed for GM and VW. The finish is black oxide with sturdy, fluted plastic handle.

Model No.	Length	Weight
1002	8" (20.3 cm)	.33 lbs (.15 kg)

Mini Clip Remover Tools

Herramientas para extracción de grapas pequeñas

Outils de dégagement de mini-attaches

To be used where clearance is a problem. These tools are similar to the **No. 1001** and **No. 1002**, just smaller in size.



Model No.	Length	Weight
1008	8" (20.3 cm)	.2 lbs (.09 kg)
1009	8" (20.3 cm)	.2 lbs (.09 kg)

Four Piece Upholstery Clip Set

Equipo de grapas de tapizado de cuatro piezas

Jeu d'attaches de garnissage de quatre pièces

Set features unique designs to make the removal of door panels and other trim easier. The mini clip tools are made to allow easy removal of smaller size moldings, tacks, and clips where clearance is a problem. Great for weather stripping.

Set consists of:

- No. 1001 Upholstery Clip Remover
- No. 1002 Upholstery Clip Remover
- No. 1008 Mini Clip Remover
- No. 1009 Mini Clip Remover



Model No.	Description	Weight
1000	4 Pc. Upholstery Clip Set	1 lb (.45 kg)

Door Handle Tool - Pliers Type

Herramienta para manija de puerta – Tipo tenaza

Outil de poignée de portière - type pinces

Removing the door handle is an easy, quick operation with the Oldforce pliers.

Use the long thin jaws to roll out the spring clips on older Ford and GM cars. The pliers are made of high grade spring steel with a bright luster finish.



Model No.	Description	Weight
1003	8" (20.3 cm)	.21 lbs (.1 kg)

Door Handle Tool

Herramienta para manija de puerta

Outil de poignée de portière

Quickly remove the door handle spring clip with a single push. When the clip is removed it is retained in the handle for easy installation. The tool has a black oxide finish.



Model No.	Description	Weight
1004	7" (17.8 cm)	.16 lbs (.07kg)

Trim Remover Tool

Herramienta para extracción de recortes

Outil de dégagement d'habillage intérieur

V-notch groove removes a variety of door and body trim fasteners. Long curved shank supplies plenty of leverage for the most difficult trim fasteners. When properly used, this tool will not damage trim or body. Black oxide finish with sturdy, fluted plastic handle.



Model No.	Length	Weight
1006	8" (20.3 cm)	.44 lbs (.2 kg)

Hook Tool • Herramienta de gancho • Crochet

The complex hook design will remove rubber seals, weather stripping, pick out broken glass from window channels, remove hog rings on seat covers and pull cotter keys and snap rings. The hook tool has a forged steel alloy blade with a black oxide finish and a sturdy fluted plastic handle.



Model No.	Length	Weight
1010	8" (20.3 cm)	.25 lbs (.11 kg)

Four Piece Door Service Set

Equipo de mantenimiento para puertas de cuatro piezas

Jeu de quatre pièces pour l'entretien de portières

Now an assortment of door service tools is available in a compact and space saving set. A handy tool set that handles a wide range of service applications.

Set consists of:

- 1001 Upholstery Clip Remover
- 1002 Upholstery Clip Remover
- 1004 Door Handle Tool
- 1006 Door and Body Trim Remover



Model No.	Description	Weight
7524	4 Pc. Door Service Set	1.4 lbs (.63 kg)

Awl • Punzón • Alêne

A handy tool for aligning work, scribing and punching holes. The handle is sturdy, fluted plastic and the finish is black oxide.



Model No.	Stock	Blade Length	Weight
1013	5/16" (8 mm)	4" (10.2 cm)	.26 lbs (.12 kg)

Brake Tools

Herramientas para frenos • Outils pour freins

Brake Spring Pliers

Pinza para resorte de frenos

Pince à ressorts de freins

These brake spring pliers remove and install brake springs on most cars and trucks. Forged from alloy steel for long wear, and designed with narrow points for in-line pull on springs. The finish is bright luster plate.



Model No.	Description	Length	Weight
1039	Standard Type	13" (33 cm)	.83 lbs (.38 kg)

Brake Adjusting Tool For Small Import Cars
Herramienta para el ajuste de frenos de automóviles importados pequeños

Outil de réglage des freins pour voitures compactes importées

Designed for the VW Rabbit, Jetta, Scirocco, Audi, Nissan (Stanza and Sentra), Honda Accord and Prelude with drum brakes which have access holes. The finish is bright luster plate.

Model No.	Length	Weight
1028	5-1/4" (13.3 cm)	.1 lbs (.05 kg)



Brake Adjusting Tool
Herramienta para el ajuste de frenos
Outil de réglage des freins

Designed for Ford, Mercury with drum brakes, General Motors vehicles with brake adjuster slots on the brake drum, small pick-up trucks, including Ford, Dodge, GMC, Chevrolet, Jeep and several pre-1980 imports - Toyota, Datsun, Mazda cars and pick ups. The finish is bright luster plate.

Model No.	Length	Weight
1030	7" (17.8 cm)	.24 lbs (.11 kg)



Angled end

Designed for General Motors full size cars and pick-ups, medium duty trucks, cab and chassis motor homes, vans (both Chrysler and GM), Ford light trucks and older cars with front drum brakes. The finish is bright luster plate.

Model No.	Length	Weight
1031	9" (22.9 cm)	.33 lbs (.15 kg)



Angled, notched end

The tang is set at 45° on one end for front brakes, and 29° on the other end for rear brakes.

Model No.	Length	Weight
1032	8-1/2" (21.5 cm)	.3 lbs (.13 kg)



Angled, notched end

Designed for both left and right side brake star wheels on rear wheel drive Chrysler and General Motors vehicles. The finish is bright luster plate.

Model No.	Length	Weight
1034	9" (22.9 cm)	.33 lbs (.15 kg)



Use to adjust Bendix brakes with star adjusting nut and other self-adjusting brakes, except for Chevrolet. 1/2" wide blade, 1/32" tip thickness.

Model No.	Length	Weight
1035	7-3/4" (19.6 cm)	.25 lbs (.11 kg)

Brake Shoe Retaining Spring Tool
Herramienta para anillos de retención de calzo
Outil pour ressort-arrêt de segment de frein

This tool will remove and replace dish-type washers. The knurled cup securely grips the washer on both small and full size vehicles. The handle is a sturdy, fluted plastic. The tool has a contrasting black oxide and bright luster plate finish.



Model No.	Length	Weight
1044	5-1/4" (13.3 cm)	.23 lbs (.1 kg)

Retainer Spring Tool
Herramienta para anillos de retención
Outil pour ressort-arrêt

This tool's special head design and comfortable plastic handle, allow for easy installation of smaller diameter retainer springs found on brake assemblies for newer and smaller vehicles.



Model No.	Length	Weight
1042	5-1/4" (13.3 cm)	.34 lbs (.15 kg)

Brake Spring Tool
Herramienta para resortes de frenos
Outil pour ressort de frein



One end of this brake spring tool has a special socket for removing the return spring. The other end is forged for replacing the spring. Finished in bright luster plate.

Model No.	Length	Weight
1045	8" (20.3 cm)	.3 lbs (.14 kg)

Brake Spring Removal Tool
Herramienta para la extracción de resortes de freno
Outil de dégagement de ressort de frein



This tool's special concave socket head and comfortable polymer handle allow for easier removal of brake springs on drum brake assemblies found on full-sized automobiles and light trucks.

Model No.	Length	Weight
1046	9" (22.9 cm)	.33 lbs (.15 kg)

Brake Spring Installing Tool
Herramienta para la instalación de resortes de frenos
Outil de montage de ressort de frein



The special angled shank and notch simplify the installation of brake springs.

Model No.	Length	Weight
1047	9" (22.9 cm)	.34 lbs (.15 kg)

Seven Piece Brake Tool Set
Equipo de herramientas para frenos de siete piezas
Jeu d'outils pour freins de sept pièces

Comprehensive brake tool set to fit all your drum brake needs. Set contains the most popular and commonly used brake service tools. Excellent for all general service brake work.

Set includes:

- 1032 Brake Adjusting Tool
- 1035 Brake Adjusting Tool
- 1039 Universal Brake Spring Pliers
- 1042 Retainer Spring Tool
- 1044 Brake Shoe Retaining Spring Tool
- 1046 Brake Spring Removal Tool
- 1047 Brake Spring Installing Tool

Model No.	Description	Weight
7547	7 Pc. Brake Tool Set	2.7 lbs (1.2 kg)



Specialty Screwdrivers

Destornilladores especializados • Tourne-vis spécialisés

Offset Slotted Style Screwdrivers

Destornilladores de compensación ranurados

Tournevis coudés à fente

The finish is bright luster plate.



Model No.	Blade Width	Length	Weight
6921	1/4" (.63 cm)	3" (7.6 cm)	.03 lbs (.01 kg)
6923	5/16" (.8 cm)	4" (10.2 cm)	.04 lbs (.02 kg)
6924	3/8" (1 cm)	4-1/4" (10.8 cm)	.08 lbs (.04 kg)
6925	1/2" (1.3 cm)	5" (12.7 cm)	.15 lbs (.07 kg)
6926	5/8" (1.6 cm)	6" (15.2 cm)	.26 lbs (.12 kg)

Five Piece Offset Slotted Screwdriver Set

Equipo de destornilladores de compensación ranurados de cinco piezas • Jeu de tournevis coudés à fente de cinq pièces

Set consists of: No. 6921, No. 6923, No. 6924, No. 6925, No. 6926.

Model No.	Description	Weight
7341	5 Pc. Offset Slotted Style Screwdriver Set	.58 lbs (.26 kg)

Super Long Screwdrivers

Destornillador extra largo • Tournevis ultra long

Black oxide finish.



Model No.	Blade Width	Blade Length	Overall Length	Weight
5218P	Phillips	18" (45.7 cm)	21-7/8" (56 cm)	.4 lbs (.18 kg)



Model No.	Blade Width	Blade Length	Overall Length	Weight
5724	1/4" (.63 cm)	24" (61 cm)	28" (71.1 cm)	.6 lbs (.27 kg)



Model No.	Blade Width	Blade Length	Overall Length	Weight
6019	1/2" (1.2 cm)	19" (48.3 cm)	25" (63.5 cm)	3 lbs (1.4 kg)

Three Piece Super Long Screwdriver Set

Equipo de destornilladores extra largos de tres piezas

Jeu de tournevis ultra longs de trois pièces

Set consists of: No. 5218P, No. 5724, No. 6019.

Model No.	Description	Weight
7343	3 Pc. Super Long Screw Driver Set	4 lbs (1.8 kg)

Thread Type Operation Accessories

Accesorios para operaciones de tipos de rosca

Accessoires utilitaires de type fileté

Screw Extractors Fluted Type

Extractores de tornillos tipo acanalado

Extracteurs de vis de type cannelé

Screw extractor drill size is stamped on each tool. Finished in black oxide.



Model No.	Bolt Size	Drill Size	Weight
6961	1/4" - 5/16" (6 - 8 cm)	1/8"	.03 lbs (.01 kg)
6962	3/8" (10 cm)	3/16"	.03 lbs (.01 kg)
6963	7/16" (12 cm)	15/64"	.04 lbs (.01 kg)
6964	1/2" - 9/16" (14 cm)	5/16"	.07 lbs (.03 kg)
6965	5/8" (16 cm)	3/8"	.11 lbs (.05 kg)
6966	3/4" (20 cm)	15/32"	.21 lbs (.1 kg)
6967	7/8" (24 cm)	9/16"	.28 lbs (.13 kg)
6968	1-1/8" (30 cm)	21/32"	.46 lbs (.21 kg)
6969	1-1/4" - 1-3/8" (36 cm)	13/16"	.73 lbs (.33 kg)

Screw Extractor Sets

Equipos de extractores de tornillos

Jeux d'extracteurs de vis

5 Piece Screw Extractor Set - Fluted Type

Equipo de extractores de tornillos de cinco piezas- Tipo acanalado

Jeu d'extracteurs de vis de 5 pièces - Type cannelé

Five extractors with sharp, undercut edges to provide solid grip on studs, set screws, pipe and Alemite fittings. Packed in convenient vinyl pouch. Drill size is stamped on each tool for easy identification. Black oxide finish.

Set consists of:

No.	Bolt Size	Length
6961	1/4" - 5/16"	2-7/16"
6962	3/8"	2-5/8"
6963	7/16"	2-7/8"
6964	1/2" - 9/16"	3"
6965	5/8"	3-1/4"



Model No.	Description	Weight
7332	5 Pc. Set	.5 lbs (.23 kg)

4 Piece Screw Extractor Set - Fluted Type

Equipo de extractores de tornillos de cuatro piezas- Tipo acanalado

Jeu d'extracteurs de vis de 4 pièces - Type cannelé

Our four largest screw extractors, packed in a heavy, durable leatherette pouch. Drill size is stamped on each tool. Black oxide finish.

Set consists of:

No.	Bolt Size	Length
6966	3/4"	3-15/16"
6967	7/8"	4-1/2"
6968	1" - 1-1/8"	4-7/8"
6969	1-1/4" - 1-3/8"	5-3/8"



Model No.	Description	Weight
7331	4 Pc. Set	1.7 lbs (.8 kg)

Punches

Punzones y soportes • Poinçons & support

Roll Pin Punches

Punzones de clavo para rodillos

Poinçons pour goupilles cylindriques

Use a roll pin punch to apply force to the center of the pin you wish to move, not the edges of the pin or the hole wall. The round ball makes contact with the center of the pin and reduces the chance for damage to the pin or surrounding surfaces.

Model No.	Point Size	Pin length	Overall Length	Body Size	Weight
3910	3/32" (2 mm)	1" (2.5 cm)	3-1/2" (9 cm)	1/4" (.6 cm)	.04 lbs (.02 kg)
3911	1/8" (3 mm)	1-1/4" (3.1 cm)	3-1/2" (9 cm)	1/4" (.6 cm)	.04 lbs (.02 kg)
3912	5/32" (4 mm)	2" (2 cm)	4-1/2" (11.4 cm)	5/16" (.8 cm)	.07 lbs (.03 kg)
3913	3/16" (5 mm)	2" (2 cm)	4-1/2" (11.4 cm)	5/16" (.8 cm)	.09 lbs (.04 kg)
3914	1/4" (6 mm)	3-1/2" (9 cm)	5-1/2" (14 cm)	3/8" (1 cm)	.14 lbs (.06 kg)
3915	5/16" (8 mm)	3-1/2" (9 cm)	6" (15.2 cm)	3/8" (1 cm)	.17 lbs (.08 kg)

Six Piece Roll Pin Punch Set

Equipo de punzones de clavo para rodillos de seis piezas

Jeu de poinçons pour goupilles cylindriques de six pièces

Set consists of: No. 3910, No. 3911, No. 3912, No. 3913, No. 3914, No. 3915.

Model No.	Description	Weight
7314	6 Pc. Roll Pin Punch Set	.48 lbs (.22 kg)

Aligning & Pry Bars

Alineación y palancas • Leviers & barres d'alignement

Aligning Bars

Barras de alineación • Barres d'alignement

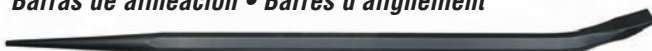

A forged, alloy steel, heat-treated bar that can be used for prying, aligning and positioning many heavier jobs in the shop. The finish is black oxide.

Model No.	Stock	Length	Weight
7025	5/8" (16 mm)	18" (45.7 cm)	1.4 lbs (.6 kg)
7026	3/4" (19 mm)	20" (50.8 cm)	2.3 lbs (1 kg)
7027	3/4" (19 mm)	24" (61 cm)	2.8 lbs (1.3 kg)
7028	7/8" (22 mm)	30" (76.2 cm)	5 lbs (2.3 kg)

Close Quarters Bars

Barras de cuartos cerrados

Barres à distance rapprochée



These bars are made of forged, alloy steel, and heat-treated. Designed for use in tight spots, their balanced construction provides very powerful leverage. The finish is black oxide.

Model No.	Stock	Length	Weight
7030	3/8" (10 mm)	9" (22.9 cm)	.31 lbs (.14 kg)
7031	1/2" (13 mm)	16" (40.6 cm)	.89 lbs (.4 kg)
7032	5/8" (16 mm)	18" (45.7 cm)	1.5 lbs (.7 kg)

Die Setter Bars

Barras troqueladoras • Barres de monteur de matrices



A practical and useful shop tool for the quick separation of punch and die holder. The bars are made of forged, alloy steel and heat-treated for strength. The finish is black oxide.

Model No.	Stock	Length	Weight
7035	5/8" (16 mm)	18" (45.7 cm)	1.7 lbs (.8 kg)
7037	3/4" (19 mm)	30" (76.2 cm)	4.2 lbs (1.9 kg)

Roll Head Pry Bars

Palancas de cabeza cilíndrica • Leviers à tête de rouleau



Use for many prying, positioning, and aligning jobs. Small sizes can be used for many jobs in the shop. Forged from top-quality steel. Heat-treated to resist bending and breaking. Roll head increases leverage.

Model No.	Stock	Length	Weight
● 34212	9/16" (14 mm)	12" (31 cm)	.8 lbs (.3 kg)
● 34216	5/8" (16 mm)	16" (41 cm)	1.3 lbs (.6 kg)
● 34218	3/4" (19 mm)	18" (46 cm)	2.0 lbs (.9 kg)

Jimmy Pry Bars

Palancas Jimmy • Leviers pince monseigneur



Long pointed taper can be used as a lining-up bar. Used for prying, positioning, and aligning.

Model No.	Stock	Length	Weight
● 34118	11/16" (17 mm)	18" (46 cm)	2.5 lbs (1.1 kg)
● 34124	3/4" (19 mm)	24" (61 cm)	2.5 lbs (1.1 kg)
● 34130	7/8" (22 mm)	30" (76 cm)	4.5 lbs (2.0 kg)

Pry Bars With Handles

Palancas con mango

Leviers avec manches



These pry bars are made of high quality forged and heat-treated alloy steel and they also have a fluted plastic handle for comfortable grip and use. They are ideal for prying cylinder heads, manifolds, transmission cases and line components. The finish is black oxide.

Model No.	Stock	Length	Weight
7231	5/16" Hex (8 mm)	12-1/8" (30.8 cm)	.35 lbs (.16 kg)
7233	3/8" Hex (10 mm)	15" (38.1 cm)	.6 lbs (.27 kg)
7235	1/2" Hex (13 mm)	16-5/8" (42.2 cm)	1.1 lb (.5 kg)
7236	3/8" sq. (10 mm)	11" (27.9 cm)	.51 lbs (.23 kg)
7237	3/8" sq. (10 mm)	16-3/4" (42.5 cm)	.7 lbs (.31 kg)
7238	1/2" sq. (13 mm)	26-1/4" (66.7 cm)	1.9 lbs (.9 kg)
7239	1/2" sq. (13 mm)	32-1/2" (82.5 cm)	2.3 lbs (1 kg)

Three Piece Pry Bar With Handles Set

Equipo de palancas con mango de tres piezas

Jeu de leviers avec manches de trois pièces

Set consists of: No. 7231, No. 7233, No. 7235.

Model No.	Description	Weight
7355	3 Pc. Pry Bar w/handles Set	2.2 lbs (1 kg)

Four Piece Pry Bar With Handles Set

Equipo de palancas con mango de cuatro piezas

Jeu de leviers avec manches de quatre pièces

Set consists of: No. 7236, No. 7237, No. 7238, No. 7239.

Model No.	Description	Weight
7360	4 Pc. Pry Bar w/handles Set	6.7 lbs (3 kg)

Magna Series

Pry Bars

With Shaft through handle.

Palancas de la serie Magna • Leviers de série Magna

These pry bars are made of high quality forged and heat-treated alloy steel. They also have a fluted plastic handle for comfortable grip and use. The difference is that the shaft of the tool goes completely through the handle. They are ideal for prying cylinder heads, manifolds, transmission cases and line components. The finish is black oxide.

Model No.	Stock	Length	Weight
7250	3/8" sq. (10 mm)	11" (27.9 cm)	.6 lbs (.27 kg)
7251	3/8" sq. (10 mm)	16-3/4" (42.5 cm)	.8 lbs (.36 kg)
7252	1/2" sq. (13 mm)	26-1/4" (66.7 cm)	2 lbs (.9 kg)
7253	1/2" sq. (13 mm)	31-1/4" (79.4 cm)	2.4 lbs (1 kg)

Four Piece Magna Series Pry Bar Set

Equipo de palancas de la serie Magna de cuatro piezas

Jeu de leviers de série Magna de quatre pièces

Set consists of: No. 7250, No. 7251, No. 7252, No. 7253.

Model No.	Description	Weight
7330	4 Pc. Magna Pry Bar Set	5.2 lbs (2.4 kg)

Stud Remover

Desmontador de tuercas • Extracteur de goujons

Stud Remover

Desmontador de tuercas • Extracteur de goujons

This compact, powerful stud remover will fit into hard to reach areas and loosen hard to turn studs. The tighter the stud, the more firmly the tool grips. The stud remover is made of high grade, heat-treated, alloy steel. The finish is bright luster plate.

Model No.	Height	Weight
2526	2" (2.5 cm)	.8 lbs (.3 kg)



Special Purpose Tools

Herramientas especializadas • Outils à usage spécifique

Welder's Chipping Hammer

Martillo de cincelar para soldadores

Marteau burineur pour soudeurs

This sturdy, alloy steel chipping hammer is heat-treated for long life and is a necessity wherever welding is done. One end is a pointed pick and the other end is a chisel. The hammer has a natural finish with a tough, fluted plastic handle. **REMEMBER—ALWAYS WEAR PROTECTIVE EQUIPMENT WHEN USING THIS TOOL.**

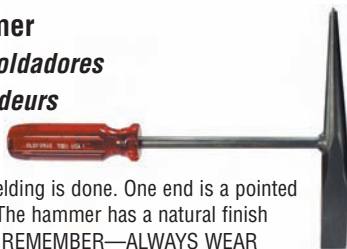

Model No.	Chisel	Length	Weight
7002	5/8" (1.6 cm)	10-3/4" (27.3 cm)	.75 lbs (.34 kg)
7003	3/4" (1.9 cm)	10-3/4" (27.3 cm)	1 lb (.5 kg)

Hose Clamp Pliers

Tenazas para abrazaderas de mangueras

Pincas étrangleur de tuyau

Easily remove and install spring wire hose clamps. These pliers also have a three position lock, and the jaws will swivel 180 degrees. The finish is bright luster plate.



Model No.	Length	Weight
7045	9" (22.9 cm)	.45 lbs (.2 kg)

Seal Puller

Extractor de juntas • Extracteur de joints d'étanchéité

Remove the most stubborn seals from transmissions, axles and those seals that are difficult to reach, with this heavy-duty seal puller. The finish is black oxide.



Model No.	Length	Stock	Weight
7019	12-1/2" (31.8 cm)	1/2" sq. (13 mm)	1.2 lbs (.5 kg)

Radiator Hose Tool

Herramientas para la manguera del radiador

Outil pour durites de radiateur

This tool is specially designed to remove radiator and heater hoses. The pointed tip is inserted between the hose and the radiator outlet. Moving the tool around the outlet will break the hose loose for easy removal.



Model No.	Blade Length	Overall Length	Weight
7046	5" (12.7 cm)	9" (22.9 cm)	.28 lbs (.12 kg)

Extra Long Radiator Hose Tool

Herramienta para la manguera del radiador extra larga

Outil pour durites de radiateur ultra longs

Specially designed for the removal of radiator and heater hoses. Same quality and features as our standard length tool, but with extra long blade for those hard-to-reach places.



Model No.	Blade Length	Overall Length	Weight
7048	11" (27.9 cm)	15" (38.1 cm)	.54 lbs (.24 kg)

Headlight Adjusting Spring Hook

Gancho de resorte para el ajuste de faros delanteros

Mousqueton pour réglage de phares

This heat-treated steel hook is strong. Designed to remove and install headlight adjusting springs, the long, slim hook makes the job a cinch. The handle is sturdy, durable, fluted plastic. The finish is black oxide.



Model No.	Length	Weight
7055	6" (15.2 cm)	.09 lbs (.04 kg)

53 Piece Universal Rethreader Set

Equipo Rethreader universal de 53 piezas

Outil universel à refaire les filets, jeu de 53 pièces

This is a set of external chasers (19) and internal chasers (32) that are designed to restore the threads to **Standard Coarse, SAE, Fine and Metric sizes**. The set is color coded; Plated are Standard Coarse, Black are SAE Fine and Gold are Metric. The set also contains two thread files, one coarse and fine pitch and the other metric pitch. Packaged in a durable plastic case with two latching fasteners. The case has a cavity for each piece for easy tool control. The case will lie flat in your tool box.



Sizes range from:

Coarse: 1/4"-20 to 3/4"-10

SAE Fine: 1/4"-28 to 3/4"-16

Metric: 6 x 1mm to 20 x 1.5mm

Model No.	Weight
7095	4.7 lbs (2.1 kg)

Thread Files • Limas para roscas • Limes à filets

Restore battered, rusted and corroded threads quickly. All the thread sizes are clearly marked on the file. Select the correct size for the thread, overlap the file to a few good threads, and use the tool just like a file to restore the damaged area. The file is 7/16" square x 8-1/2".



Model No.	Length	Stock	Weight
7090	8-1/2" (21.6 cm)	7/16" sq. (11 mm)	.36 lbs (.16 kg)
For Metric .75 mm, 1 mm, 1.25 mm, 1.5 mm, 1.75 mm, 2 mm, 2.5 mm, 3 mm.			
7092	8-1/2" (21.6 cm)	7/16" sq. (11 mm)	.38 lbs (.17 kg)
For 9, 10, 12, 16, 20, 27, 28 and 32 T.P.I. threads.			
7093	8-1/2" (21.6 cm)	7/16" sq. (11 mm)	.37 lbs (.17 kg)
For 11, 12, 13, 14, 16, 18, 20 and 24 T.P.I. threads.			

Muffler Tools

Herramientas para silenciadores

Outils pour silencieux

These muffler tools are designed to make a difficult job as easy as possible, without the use of power equipment. Tools have bright luster plate finish.

Tailpipe Remover

Desmontador de caño de escape

Dégageur de tuyaux d'échappement arrière

Here is the Oldforge "Curl-Cut™", designed into a tool that will separate the muffler and tailpipe with a few light taps. The tailpipe remover will also cut sheet metal.



Model No.	Length	Stock	Weight
1945	10" (25.4 cm)	1/2" (13 mm)	.53 lbs (.24 kg)

Muffler Remover

Desmontador de silenciador • Dégageur de silencieux

Insert the tool between the tailpipe and muffler nipple, and split open whichever is outside. Rusted and corroded connections are no problem. You will get a clean, controlled cut with this "Curl-Cut™" design.



Model No.	Length	Stock	Weight
1948	8" (20.3 cm)	1/2" (13 mm)	.46 lbs (.21 kg)

Muffler and Tailpipe Remover

Desmontador de caño de escape y silenciador

Dégageur de silencieux et de tuyaux d'échappement arrière

Here is a different approach to the same, tough problem. The blade has a convex shape, which will slide between the muffler nipple and the tailpipe. With a few sharp taps the rust and corrosion will break and the parts will be separated.



Model No.	Length	Stock	Weight
1949	11" (27.9 cm)	1/2" (13 mm)	.71 lbs (.32 kg)

Air Blow Guns

Pistolas de soplado de aire • Soufflettes

Stainless Steel with Telescoping Shaft

Acero inoxidable con eje extensible

En acier inoxydable avec manche télescopique



Patented air release for safety.

Telescope must be manually adjusted. Air will not cause telescoping shaft to extend automatically.

Our telescoping air blow gun goes from pistol to rifle length, without having to change gun or position, or having to thread on some awkward extension. U.S. Patent No. 6,283,340 B1.



Model	EDP No.	Couplings	Telescope Range	Weight
ABGTEL1	17065	1/4" NPT Female In + 1/8" NPT Female Out	12" to 36" 30.4 cm to 91.4 cm	.3 lbs .13 kg

Durable Nylon Shaft with Articulated Joints

Eje de nylon durable con juntas articuladas

Manche durable en nylon avec articulations



Air release for safety.

When you want to blast away in difficult places, our flexible air blow gun can reach around those tough corners so nothing stands in your way. Flexible shaft to get to those hard-to-reach areas. Lightweight. U.S. Patent No. 6,752,335.

Model	EDP No.	Couplings	Telescope Range	Weight
ABGPV1	17055	1/4" NPT Female In + 1/8" NPT Female Out	13" Total 33 cm	.25 lbs .11 kg

3 Pc. Interchangeable Air Blow Gun Set

3 piezas Equipo de pistolas de soplado de aire intercambiables

Jeu de soufflettes interchangeables de trois pièces

Set includes: **One air blow gun grip and two nozzles.** One nozzle is a durable nylon flexible shaft with articulated joints, and the second nozzle is a stainless steel telescoping shaft that extends from 12" to 36". (All 3 pieces shown above.)

NEW	Model	EDP No.	Description	Telescope Range	Weight
	17255	17255	3 Pc. Set	12" to 36"	.5 lbs (.22 kg)

TELESCOPING & UNIQUE SPECIALTY TOOLS

*TELESCOPIAJE Y HERRAMIENTAS
ESPECIALIZADAS EXCLUSIVAS*

*OUTILS DE TÉLESCOPAGE ET
SPÉCIAUX UNIQUES*

*Reach Further,
See Clearer,
Retrieve the
Unretrievable...*

AIR BLOW GUNS

STETHOSCOPE • PICKS

MEGAPRO® TOOL

MAGNIFIERS • MIRRORS

MAGNETS • PEN TOOLS

PICK-UP TOOLS

INSPECTION TOOL KITS

FLEXIBLE SHAFT TOOLS

ILLUMINATED INSPECTION TOOLS

*Carica Tools are specialized for
automotive, industrial, HVAC,
aerospace, and security*

Stethoscope • Estetoscopio • Stéthoscope

Mechanic's Telescoping Stethoscope

*Estetoscopio extensible para mecánicos
Stéthoscope télescopique pour mécaniciens*

No longer a need for a wooden handled screwdriver to listen for engine noise. The mechanic's telescoping stethoscope amplifies sound while getting into those hard-to-reach areas. The stethoscope also telescopes for your safety to keep you away from any moving parts. Equipped with soft ear piece for comfort.

The stethoscope helps identify piston knock, water pump and alternator bearing failure, worn gears, damaged gaskets, faulty valves, and fuel injectors

Unequaled performance

- **Bell-shaped aluminum sound chamber with probe produces a more natural sound than plastic chambers**

Access hard to reach places

- **Stainless steel shaft**
- **Flexible tubing to ear piece aids positioning**
- **Rigid shaft extends, keeping hands away from heat and moving parts**
- **Soft, comfortable ear piece is replaceable***

Storage

- **Probe reverses to fit inside chamber for safe, compact storage**



Probe reversed for storage

Locate the source of engine noise quickly.



Patent Pending

Model	EDP No.	Overall Length	Weight
STETH01	17200	Extended: 36-1/2" (92.7 cm) Closed: 15-1/2" (39.3 cm) Closed with probe reversed: 11" (27.9 cm)	.2 lbs (.09 kg)

*One pair of replacement ear pieces Part No. 17205

Picks • Picos • Pics

Hook and Pick Set

Equipo de ganchos y picos

Jeu de crochet et de pic

Each hook or pick fitting is made of hardened steel that is 3" long. Includes a 3 lb. quick-connect magnet. Knurled steel non-slip-grip handle with removable end-cap holds picks inside when not in use.

U.S. Patent No. D404,632.



Carica's lightning fast, quick-change couplers make it easy to switch from one tool to the next.



Handle doubles as convenient storage compartment for fittings

Model	EDP No.	Description	Weight
HPMSET1	17650	6 Pc. Pick/Magnet Set	.25 lbs (.11 kg)

MEGAPRO® TOOLS

MEGAPRO® Herramientas

MEGAPRO® Outils

15-in-1 Automotive Screwdriver Set

Equipo de destornilladores estándar de 15 en 1

Jeu de tournevis standards 15 en 1

15 different tips for all your needs. Includes Phillips, square, torx, and slot. Patented.



Model	EDP No.	Description	Weight
151AU-50	17125	Standard with 15 bits	.5 lbs (.22 kg)

Telescoping Magnifiers and Mirrors

Espejos y lupas extensibles

Loupes et miroirs télescopiques



All telescoping magnifiers and mirrors swivel 180°, and will hold in position for those hard to reach places. Patented.

TeleMirror™ Telescoping Steel and Glass Magnifying Mirrors

TeleMirror™ Espejos de aumento de vidrio y acero extensibles

TeleMirror™ Miroirs grossissants télescopiques de glace et acier

Stainless steel backer holds tempered glass mirror securely.
Flame retardant, stainless steel, heat resistant mirror.
Stainless steel swivel assembly swivels 180°.
Solvent-resistant PVC Grips.



Swivels 180°.

Model	EDP No.	Dimensions	Telescope Range	Weight
GMR01	17630	2-1/4" x 2-1/2" 5.7 cm x 6.3 cm	7" to 28-1/2" 17.7 cm to 72.3 cm	.2 lbs .09 kg



MGMR01 Magnifies everything by 3x. Swivels 180°.

Model	EDP No.	Dimensions	Telescope Range	Weight
MGMR01	17770	2-1/4" x 2-1/2" 5.7 cm x 6.3 cm	7" to 28-1/2" 17.7 cm to 72.3 cm	.2 lbs .09 kg

TeleMirror™ Polished Steel Mirror

TeleMirror™ Espejo de acero pulido

TeleMirror™ Miroir en acier poli

Flame retardant,
stainless steel heat resistant mirror. Swivels 180°.



Model	EDP No.	Dimensions	Telescope Range	Weight
SSMR01	17150	2" x 3-3/4" 5 cm x 9.5 cm	6-3/4" to 28-1/2" 17.1 cm to 72.3 cm	.15 lbs .06 kg

TeleMirror™ Telescoping Acrylic Mirrors

TeleMirror™ Espejos de acrílico extensibles

TeleMirror™ Miroirs télescopiques en acrylique

Replaceable shatter-resistant acrylic mirrors.
Protective mirror covers. Solvent-resistant PVC grip.



Swivels 180°.

Model	EDP No.	Dimensions	Telescope Range	Weight
MR01	17750	2-1/4" x 3.6" 5.7 cm x 9.1 cm	7-3/4" to 35-1/2" 19.6 cm to 90.1 cm	.15 lbs .06 kg



Patented ball swivel provides ultra-quick mirror positioning. Swivels 180°, rotates 360°.

Model	EDP No.	Dimensions	Telescope Range	Weight
MR02	17755	1-3/4" x 2-1/2" 4.4 cm x 6.3 cm	6-1/2" to 27-1/2" 16.5 cm to 69.8 cm	.1 lb .04 kg



Patented ball swivel provides ultra-quick mirror positioning. Swivels 180°, rotates 360°.

Model	EDP No.	Dimensions	Telescope Range	Weight
MR03	17760	3/4" x 2-1/2" .4 cm x 6.3 cm	6-1/2" to 27-1/2" 16.5 cm to 69.8 cm	.1 lb .04 kg

3 times more image area than our next biggest model! Swivels 180°.

Model	EDP No.	Dimensions	Telescope Range	Weight
MR04	17765	4" x 6" 10.1 cm x 15.2 cm	8-1/2" to 37" 21.5 cm to 93.9 cm	.25 lbs .11 kg

TeleFier™ Telescoping Acrylic Magnifier

TeleFier™ Lupa de acrílico extensible

TeleFier™ Loupe en acrylique télescopique

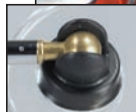

Optical-quality magnifying lenses made out of light-weight shatter-resistant acrylic. Patented ball swivel provides ultra-quick mirror positioning. Swivels 180°, rotates 360°.

Model	EDP No.	Dimensions	Telescope Range	Weight
TF01	17305	1-3/4" x 2-1/2" 4.4 cm x 6.3 cm	6-1/2" to 27-1/2" 16.5 cm to 69.8 cm	.1 lb .04 kg

Telescoping Magnets

Imanes extensibles • Doigts magnétiques

TeleMag Telescoping Magnetic Pick-Up Tools

TeleMag Herramientas de recolección magnéticas extensibles

TeleMag Ramasse-pièces magnétiques télescopiques

CaricaHed™ technology to virtually eliminate magnet sidepull. Heavy-duty stainless steel shafts. Solvent-resistant PVC grip. Shaft stays rigid at maximum length. U.S. Patent No. 6,677,845, B1.



Model	EDP No.	Magnet Capacity	Telescope Range	Weight
PMG01	17810	14 lbs 6.3 kg	7-1/2" to 32" 19 cm to 81.2 cm	.2 lbs .09 kg

Swivels 180°, rotates 360°.



Model	EDP No.	Magnet Capacity	Telescope Range	Weight
PMG02	17830	14 lbs 6.3 kg	7-1/4" to 33" 18.4 cm to 83.8 cm	.2 lbs .09 kg



Model	EDP No.	Magnet Capacity	Telescope Range	Weight
PMG03	17845	3 lbs 1.3 kg	7-1/2" to 32" 19 cm to 81.2 cm	.15 lbs .06 kg

Entire head is magnetized to create pull from top and sides.



Model	EDP No.	Magnet Capacity	Telescope Range	Weight
PMG05	17860	2 lbs .9 kg	7" to 26-1/2" 17.7 cm to 67.3 cm	.1 lb .04 kg

Telescoping Magnetic Pen Tools

Herramientas bolígrafo magnéticas extensibles

Outils de poche magnétiques télescopiques

Pen-sized tools for tiny jobs. Each precision tool telescopes to 25-1/2" (64.7 cm). Patented ball swivel for quick positioning. Swivels 180°, rotates 360°. Solid chromed brass construction.

Pick-up magnet



Model	EDP No.	Magnet Capacity	Weight
PM01	17800	1.5 lbs (.68 kg)	.07 lbs (.03 kg)

Combination pick-up magnet and swivel head mirror. Replaceable shatter-resistant acrylic mirror



Model	EDP No.	Mirror Dimensions	Magnet Capacity	Weight
PM01B-M	17805	3/4" x 2-1/2" 1.9 cm x 6.3 cm	1.5 lbs .68 kg	.05 lbs .02 kg

Pilot lighter with match-holding alligator clip. Good for HVAC and plumbing applications.



Model	EDP No.	Magnet Capacity	Weight
PL01	17780	1.5 lbs (.68 kg)	.05 lbs (.02 kg)

Telescoping Magnetic Pick-up Tool Sets

Equipos de herramientas de recolección magnéticas extensibles

Jeux de ramasse-pièces magnétiques télescopiques

Set includes:



PM01 (17800) Telescoping Magnet Pen Tool

PMG01 (17810) Fixed Head Telescoping Magnetic Pick-Up Tool

Model	EDP No.	Description	Weight
17910	17910	2 Pc. Set	.27 lbs (.12 kg)

Set includes:



PM01 (17800) Telescoping Magnet Pen Tool

PMG02 (17830) Swivel Head Telescoping Magnetic Pick-Up Tool

Model	EDP No.	Description	Weight
17930	17930	2 Pc. Set	.27 lbs (.12 kg)

Inspection / Pick-up Tool Kits

Equipos de herramientas de recolección/inspección

Trousse d'outils de ramasse-pièces/d'inspection

Each kit includes a solid, custom-fitted box with cushioned lining for storage.

TeleMag™ TK1000

Inspection / pick-up kit includes 14 lb. (6.3 kg) capacity magnet with stainless steel telescoping shaft and telescoping acrylic inspection mirror 1-3/4" x 2-1/2" (4.4 cm x 6.3 cm).

Kit Includes:

PMG01 (17810) MR02 (17755)

Model	EDP No.	Description	Weight
TK1000	17680	2 Pc. Set	.6 lbs (.27 kg)



TeleMag™ TK3000

Inspection / pick-up kit includes 14 lb. (6.3 kg) capacity *swivel head* magnet with stainless steel telescoping shaft and telescoping acrylic inspection mirror 1-3/4" x 2-1/2" (4.4 cm x 6.3 cm).

Kit Includes:

PMG02 (17830) MR02 (17755)

Model	EDP No.	Description	Weight
TK3000	17705	2 Pc. Set	.6 lbs (.27 kg)



TeleMag™ TK2000

Inspection / pick-up kit includes 14 lb. (6.3 kg) capacity magnet with stainless steel telescoping shaft and telescoping acrylic inspection magnifier.

Kit Includes:

PMG01 (17810) TF01 (17305)

Model	EDP No.	Description	Weight
TK2000	17700	2 Pc. Set	.6 lbs (.27 kg)



TeleMag™ TK4000

Inspection / pick-up kit includes 14 lb. (6.3 kg) capacity *swivel head* magnet with stainless steel telescoping shaft and telescoping acrylic inspection magnifier.

Kit Includes:

PMG02 (17830)

TF01 (17305)

Model	EDP No.	Description	Weight
TK4000	17710	2 Pc. Set	.65 lbs (.29 kg)



TeleMulti™ TK6000

Inspection / pick-up kit includes stainless steel telescoping shaft with brass quick-change coupler, acrylic inspection mirror, inspection magnifier, 14 lb. (6.3 kg) capacity magnet, and 3 lb. (1.3 kg) capacity magnet.

Kit includes:

TKSSANT (17030)

TK01MAG (17315)

TK03MAG (17325)

TKFIER (17020)

TK02MIR (17300)

Model	EDP No.	Description	Weight
TK6000	17720	5 Pc. Set	1 lb (.45 kg)



Featuring Carica's lightning-fast, quick-change couplers that make it easy to switch from one tool to the next.

NEW

NEW

FlexLine™ Flexible Shaft Tools

Herramientas para ejes flexibles

Outils pour arbre flexible



Solvent-resistant PVC grip.



Removable copper shaft

Unique dual-purpose flex shaft system: *Permanent flex*: Bend shaft into a fixed position.

Soft flex: Remove inside copper shaft, flex handle will snake into desired location.

FlexMirrors

Replaceable shatter-resistant acrylic mirror. Patented ball swivel for quick positioning. Swivels 180°, rotates 360°. Protective cover.

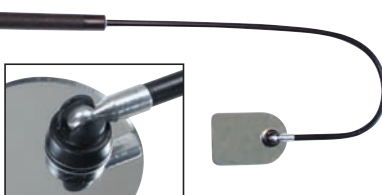

Model	EDP No.	Dimensions	Overall Length	Weight
FMR01	17615	1-3/4" x 2-1/2" 4.4 cm x 6.3 cm	23" 58.4 cm	.25 lbs .11 kg
FMR02	17620	2-1/4" x 3-1/2" 5.7 cm x 8.8 cm	23" 58.4 cm	.25 lbs .11 kg
FMR03	17625	3/4" x 2-1/2" 1.9 cm x 6.3 cm	23" 58.4 cm	.25 lbs .11 kg

FlexFier

Replaceable shatter-resistant acrylic magnifier. Patented ball swivel for quick positioning. Swivels 180°, rotates 360°. Protective cover.



Model	EDP No.	Dimensions	Overall Length	Weight
FF01	17600	1-3/4" x 2-1/2" 4.4 cm x 6.3 cm	23" 58.4 cm	.25 lbs .11 kg

FlexMag

CaricaHed™ technology to virtually eliminate magnet sidepull.



Model	EDP No.	Magnet Capacity	Overall Length	Weight
FM01	17605	3 lbs 1.3 kg	23" 58.4 cm	.25 lbs .11 kg

FlexMag

CaricaHed™ technology to virtually eliminate magnet sidepull.



Model	EDP No.	Magnet Capacity	Overall Length	Weight
FM02	17610	14 lbs 6.3 kg	23" 58.4 cm	.3 lbs .13 kg

Tool Kits

Equipos de herramientas

Troussets d'outils



Each kit includes a solid, custom-fitted box with cushioned lining for storage. Kits feature Carica's lightning-fast, quick-change couplers that make it easy to switch from one tool to the next.

Inspection / Pick-up Tool Kits

Equipos de herramientas de recolección/inspección

Troussets d'outils de ramasse-pièces/d'inspection

TeleFlex™ TK8000

Inspection / pick-up kit includes stainless steel telescoping shaft with brass quick-change coupler, flexible shaft with brass quick-change coupler, 2 acrylic inspection mirrors, inspection magnifier, 14 lb. (6.3 kg) capacity magnet, and 3 lb. (1.3 kg) capacity magnet.

Kit Includes:

- TKFLEX (17025)**
- TKSSANT (17030)**
- TK01MAG (17315)**
- TK03MAG (17325)**
- TKFIER (17020)**
- TK02MIR (17300)**
- TK03MIR (17330)**



Model	EDP No.	Description	Weight
TK8000	17730	7 Pc. Set	1.5 lbs (.68 kg)

Teluminator™ Tool Kits

Teluminator™ Equipos de herramientas

Teluminator™ Troussets d'outils

TK5000 TELU

Illuminated inspection / pick-up kit includes focusing krypton flashlight housed above a stainless steel telescoping shaft with brass quick-change coupler, two acrylic inspection mirrors, inspection magnifier, 14 lb. (6.3 kg) capacity magnet, 3 lb. (1.3 kg) capacity magnet, and spare krypton bulb. U.S. Patented No. 6,193,386.

Kit Includes:

- TKTORCH (17035)**
- TKFIER (17020)**
- TK01MAG (17315)**
- TK03MAG (17325)**
- TK02MIR (17300)**
- TK03MIR (17330)**



Model	EDP No.	Description	Weight
TK5000	17715	6 Pc. Set	1 lb (.45 kg)

TK20/20SE

Illuminated inspection / pick-up kit includes focusing krypton flashlight housed above a stainless steel telescoping shaft with brass quick-change coupler, 3 acrylic inspection mirrors, inspection magnifier, 14 lb. (6.3 kg) capacity magnet, and 3 lb. (1.3 kg) capacity magnet, 2 AA batteries, and spare krypton bulb. Patented.

Kit Includes:

- TKTORCH (17035)**
- TK01MAG (17315)**
- TK03MAG (17325)**
- TK01MIR (17320)**
- TK02MIR (17300)**
- TK03MIR (17330)**
- TKFIER (17020)**
- TK01BULB (17005)**
- TK20/20CASE (17691)**



Model	EDP No.	Description	Weight
TK20/20SE	17690	9 Pc. Set	2 lbs (.9 kg)

Hard Cap® Safety Tools, the world's most comfortable automotive tools with new performance and safety technology.

1/2" Cold Chisel

Cortafíos de 1/2 pulgadas • Ciseau plat de 1/2 po



NEW

Model No.	Blade Width	Length	Weight
65104	1/2" (1.3 cm)	7" (17.8 cm)	.32 lbs (.14 kg)

3/4" Cold Chisel

Cortafíos de 3/4 pulgadas • Ciseau plat de 3/4 po



NEW

Model No.	Blade Width	Length	Weight
65106	3/4" (1.9 cm)	8" (20.3 cm)	.82 lbs (.37 kg)

7/8" Cold Chisel

Cortafíos de 7/8 pulgadas • Ciseau plat de 7/8 po



NEW

Model No.	Blade Width	Length	Weight
65107	7/8" (2.2 cm)	8.5" (21.5 cm)	.86 lbs (.39 kg)

1" Cold Chisel

Cortafíos de 1 pulgada • Ciseau plat de 1 po



NEW

Model No.	Blade Width	Length	Weight
65108	1" (2.5 cm)	8.5" (21.5 cm)	1.2 lbs (.54 kg)

1/8" Pin Punch

Punzón de clavo de 1/8 pulgadas • Chasse-goupille 1/8 po



NEW

Model No.	Punch Size	Length	Weight
66422	1/8" (.3 cm)	7" (17.8 cm)	.27 lbs (.12 kg)

5/32" Pin Punch

Punzón de clavo de 5/32 pulgadas • Chasse-goupille 5/32 po



NEW

Model No.	Punch Size	Length	Weight
66423	5/32" (.4 cm)	7" (17.8 cm)	.27 lbs (.12 kg)

3/16" Pin Punch

Punzón de clavo de 3/16 pulgadas • Chasse-goupille 3/16 po



NEW

Model No.	Punch Size	Length	Weight
66424	3/16" (.5 cm)	7" (17.8 cm)	.27 lbs (.12 kg)

1/4" Pin Punch

Punzón de clavo de 1/4 pulgadas • Chasse-goupille 1/4 po



NEW

Model No.	Punch Size	Length	Weight
66427	1/4" (.6 cm)	7" (17.8 cm)	.34 lbs (.15 kg)

3/16" Solid Punch

Punzón sólido de 3/16 pulgadas • Poinçon plein de 3/16 po



Model No.	Punch Size	Length	Weight
66401	3/16" (.5 cm)	7" (17.8 cm)	.29 lbs (.13 kg)

7/32" Center Punch

Punzón para centrar de 7/32 pulgadas • Pointeau de 7/32 po



Model No.	Punch Size	Length	Weight
66412	7/32" (.6 cm)	7" (17.8 cm)	.29 lbs (.13 kg)

1/4" Center Punch

Punzón para centrar de 1/4 pulgadas • Pointeau de 1/4 po



Model No.	Punch Size	Length	Weight
66414	1/4" (.6 cm)	7" (17.8 cm)	.37 lbs (.16 kg)

7/32" Prick Punch

Punzón para marcar de 7/32 pulgadas

Pointeau de traçage 7/32 po



Model No.	Punch Size	Length	Weight
66435	1/4" (.6 cm)	7" (17.8)	.29 lbs (.13 kg)

3/16" Alignment Punch

Punzón para alineación de 3/16 pulgadas

Poinçon d'alignement de 3/16 po



Model No.	Punch Size	Length	Weight
66440	3/16" (.5 cm)	9" (22.8 cm)	.34 lbs (.15 kg)

1/4" Alignment Punch

Punzón para alineación de 1/4 pulgadas

Poinçon d'alignement de 1/4 po



Model No.	Punch Size	Length	Weight
66441	1/4" (.6 cm)	10" (25.4 cm)	.51 lbs (.23 kg)

5/16" Alignment Punch

Punzón para alineación de 5/16 pulgadas

Poinçon d'alignement de 5/16 po



Model No.	Punch Size	Length	Weight
66442	5/16" (.8 cm)	11" (27.9 cm)	1 lb (.5 kg)

Hard Cap® Chisel & Punch Sets
Hard Cap® Juegos de cinceles y punzones
Hard Cap® Ensembles ciseau et poinçon

Four Piece Cold Chisel Set
Juego de cortafríos de cuatro piezas
Ensemble de 4 ciseaux plats



Set consists of: No. 65104 1/2" Cold Chisel
 No. 65106 3/4" Cold Chisel
 No. 65107 7/8" Cold Chisel
 No. 65108 1" Cold Chisel

Model No.	Description	Weight
NEW 66900	4 Piece Cold Chisel Set	3.1 lbs (1.4 kg)

Four Piece Pin Punch Set
Juego de punzones de clavo de cuatro piezas
Ensemble de 4 chasse-goupilles



Set consists of: No. 66422 1/8" Pin Punch
 No. 66423 5/32" Pin Punch
 No. 66424 3/16" Pin Punch
 No. 66427 1/4" Pin Punch

Model No.	Description	Weight
NEW 66901	4 Piece Pin Punch Set	1 lb (.5 kg)

Four Piece Punch Set
Juego de punzones de cuatro piezas
Ensemble de 4 poinçons



Set consists of: No. 66401 3/16" Solid Punch
 No. 66412 7/32" Center Punch
 No. 66414 7/8" Center Punch
 No. 66435 1" Prick Punch

Model No.	Description	Weight
NEW 66902	4 Piece Punch Set	1.1 lbs (.5 kg)

Three Piece Alignment Set
Juego de alineación de tres piezas
Ensemble de 3 poinçons d'alignement



Set consists of: No. 66440 3/16" Alignment Punch
 No. 66441 1/4" Alignment Punch
 No. 66442 5/16" Alignment Punch

Model No.	Description	Weight
NEW 66907	3 Piece Alignment Set	1.8 lbs (.81 kg)

Hard Cap®
CHISELS AND PUNCHES
CINCELES Y PUNZONES DE TAPA DURA
CISEAUX ET POINÇONS À BOUT RENFORCÉ

Hard Cap Safety Tools, the world's most comfortable automotive tools with new performance and safety technology.

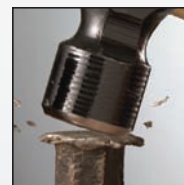

Eliminates flying fragments

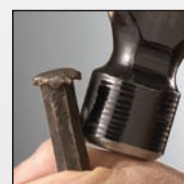

Reduces glancing blows



Eliminates mushrooming

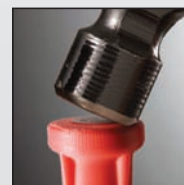

Impact disc efficiently transfers blow

- *Unbreakable, tough reinforced polymer cap*
- *Comfortable grip reduces shock by up to 90%*
- *Noise level reduced by up to 80%*
- *Striking surface is 2 1/2 times larger*
- *Hammer kickback and wrist-elbow trauma minimized*
- *Oil resistant cushion grip reduces hot-cold feel*
- *Eliminates flying chips and mushrooming of chisel heads*
- *Four cap diameters to match hammer sizes*
- *The industry's sharpest and most accurate cutting edge*
- *Additional tools and sizes available*
- *Patented • Made in U.S.A.*

All of Ken-Tool's Professional Vises feature:



- 360° swivel base
- Machined base plate for smooth swivel
- Heavy-duty jaw beam covers screw
- Built-in anvils



Jaw faces have "V" notches for vertical gripping

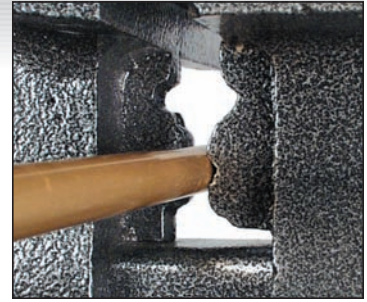

Built-in pipe jaws



- Gear-type locking system with double lock-down bolts - locks vise securely in position

"V" notched, replaceable/reversible jaws made of carbon steel and heat-treated for extra strength, diamond cut on one side - smooth on the other

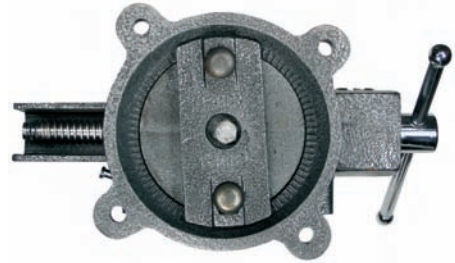

Professional Reversible Mechanic's Vises feature:

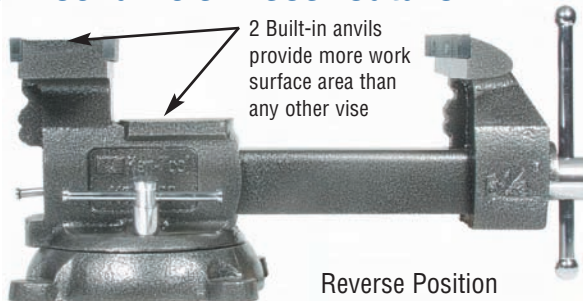
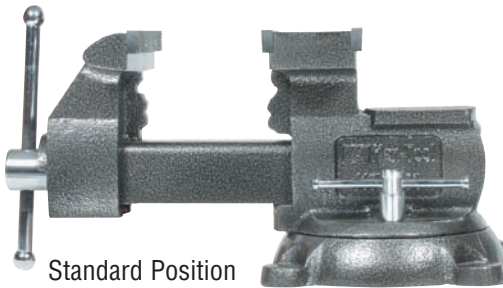

It's simple...Remove the jaw from the front of the base, swivel the base 180°, then re-insert the jaw:



Professional Workshop Vises

Tornillos de banco para taller profesionales

Étaux pour ateliers professionnels

With high quality construction for extra durability and full-strength performance at any jaw opening, these vises are made for the professional - strong, durable, and built to last.



K65 6-1/2"

Model	EDP No.	Jaw Width	Jaw Opening	Throat Depth	Pipe Jaw Capacity	Weight
K55	64055	5-1/2" 14 cm	6-1/2" 17 cm	3-3/16" 8 cm	1/8" - 2-1/2" .3 - 6 cm	30 lbs 14 kg
K65	64065	6-1/2" 17 cm	7-1/2" 19 cm	3-3/4" 10 cm	1/8" - 2-1/2" .3 - 6 cm	41 lbs 19 kg

Professional Reversible Mechanic's Vises

Tornillos de banco reversibles para mecánicos profesionales

Étaux professionnels réversibles de mécanicien

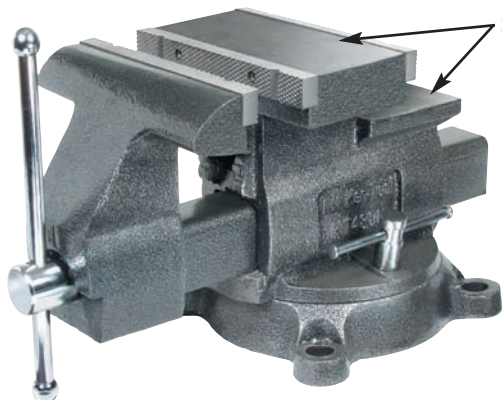

2 Built-in anvils provide more work surface area than any other vise

KT4800 8"

With our Reversible Vises you get all of the high quality features and rugged durability of the Pro Workshop Vises, and more! Significantly increase your gripping capacity when you reverse the position of the front jaw.

Model	EDP No.	Jaw Width	Jaw Opening	Throat Depth	Pipe Jaw Capacity	Weight
KT4650	64650	6-1/2" 17 cm	7" - 10" 18 - 25 cm	3-3/4" 9.5 cm	1/8" - 3" .3 - 8 cm	50 lbs 23 kg
KT4800	64800	8" 20 cm	8 - 11" 20 - 28 cm	4-3/4" 12 cm	1/8" - 3" .3 - 8 cm	74 lbs 34 kg

Professional C-Clamps

Abrazaderas en C profesionales

Serre-joints en C professionnels

This c-clamp is for the professional. Designed for strength and toughness, with sliding pin handle and acme-thread screw. Imported.



Model	EDP No.	Jaw Opening	Jaw Depth	Screw Diameter	Std. Pack	Weight
KT-4	39604	4" 10 cm	2-1/16" 5 cm	5/8" 1.5 cm	6	1.8 lbs .8 kg
KT-6	39606	6" 15 cm	2-3/4" 7 cm	5/8" 1.5 cm	6	2.5 lbs 1.1 kg
KT-8	39608	8" 20 cm	3-1/4" 8 cm	3/4" 2 cm	1	3.5 lbs 1.6 kg

Vises

PROFESSIONAL VISES & C-CLAMPS

**TORNILLOS DE BANCO PROFESIONALES
Y PRENSAS C**

**ÉTAUX PROFESSIONNELS ET
SERRE-JOINTS EN C**

Increase Your Gripping Capacity

**2 VISE STYLES FOR THE
PROFESSIONAL:
PRO WORKSHOP
PRO REVERSIBLE MECHANIC'S**





Use to demount second bead

Serpent™ Demount Tool
Herramienta de desmontaje
Outil de démontage

"Makes demounting easier than ever."

Demounts **both** beads on most truck tires without the need for lifting the tire/wheel assembly off the ground, and then dropping it. Made of heat-treated alloy steel for maximum durability and strength.

- Length: 39" (99 cm)
- Stock: 3/4" (19mm)
- U.S. Patent No's 6,712,114 and 6,913,061 and D476,205

Model	EDP No.	Weight
T2001	35449	6.5 lbs (3 kg)

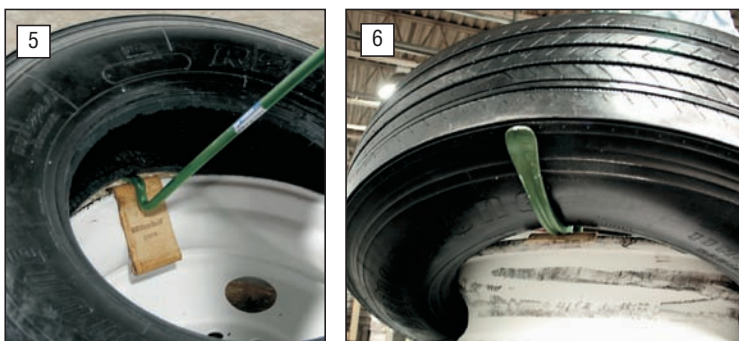
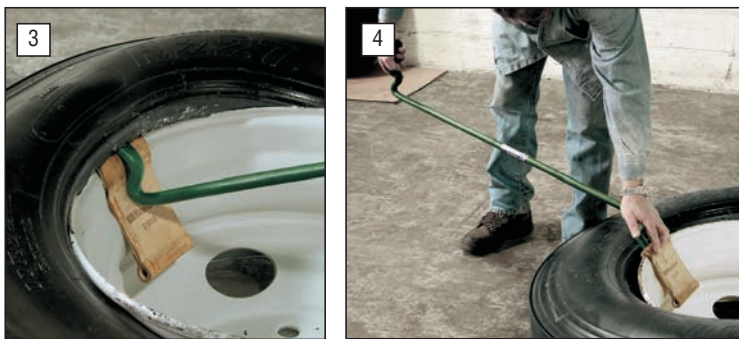

Use to demount first bead

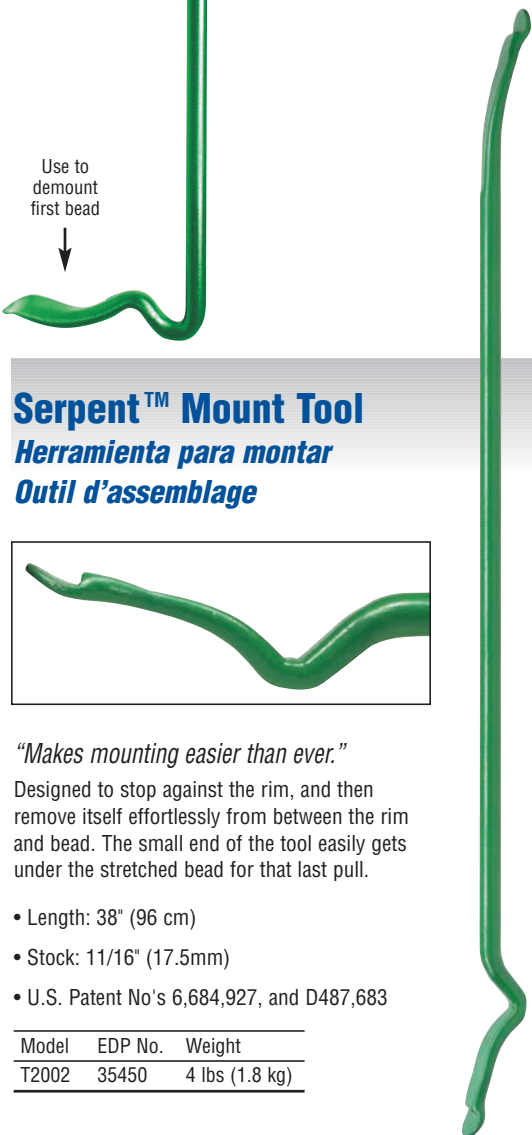

Serpent™ Mount Tool
Herramienta para montar
Outil d'assemblage



"Makes mounting easier than ever."

Designed to stop against the rim, and then remove itself effortlessly from between the rim and bead. The small end of the tool easily gets under the stretched bead for that last pull.

- Length: 38" (96 cm)
- Stock: 11/16" (17.5mm)
- U.S. Patent No's 6,684,927, and D487,683

Model	EDP No.	Weight
T2002	35450	4 lbs (1.8 kg)

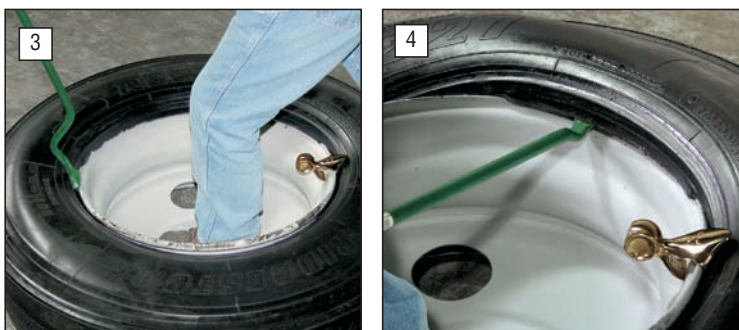
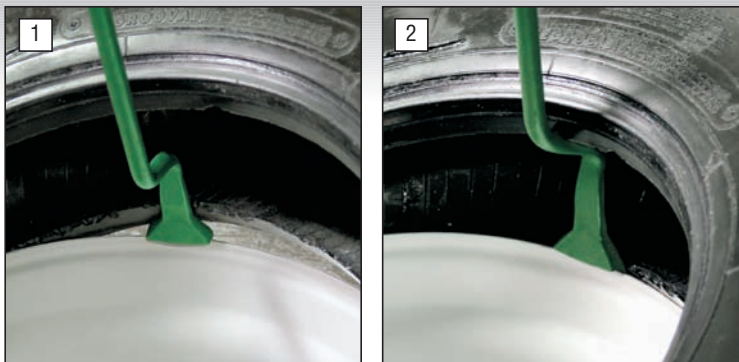

Serpent™ 4 Pc. Tire Changing Set

Juego de 4 piezas para cambiar llantas

Ensemble 4 pièces de changement de pneu

*Take the struggle out of mounting
and demounting truck tires...
Everything you need to change tires
easily and effortlessly:*

Set No. 35453

Weight: 12 Lbs. (5.4 kg)

T2001 (35449) Demount Tool

- Demounts both beads
- No more lifting the tire/wheel assembly off the ground

T2002 (35450) Mount Bar

- Designed to stop against the rim
- Won't slip into wheel well
- Small end of tool easily gets under the stretched bead for that last pull

31710 Bead Holding Device

- Holds the bead in place against the wheel while mounting a tire

31810 Wheel Protector

- Protects wheel rims from damage
- U.S. Patent No. 6,991,018



Bead Holding Device
31710
(see page 37)



Wheel Protector
31810
(see page 37)

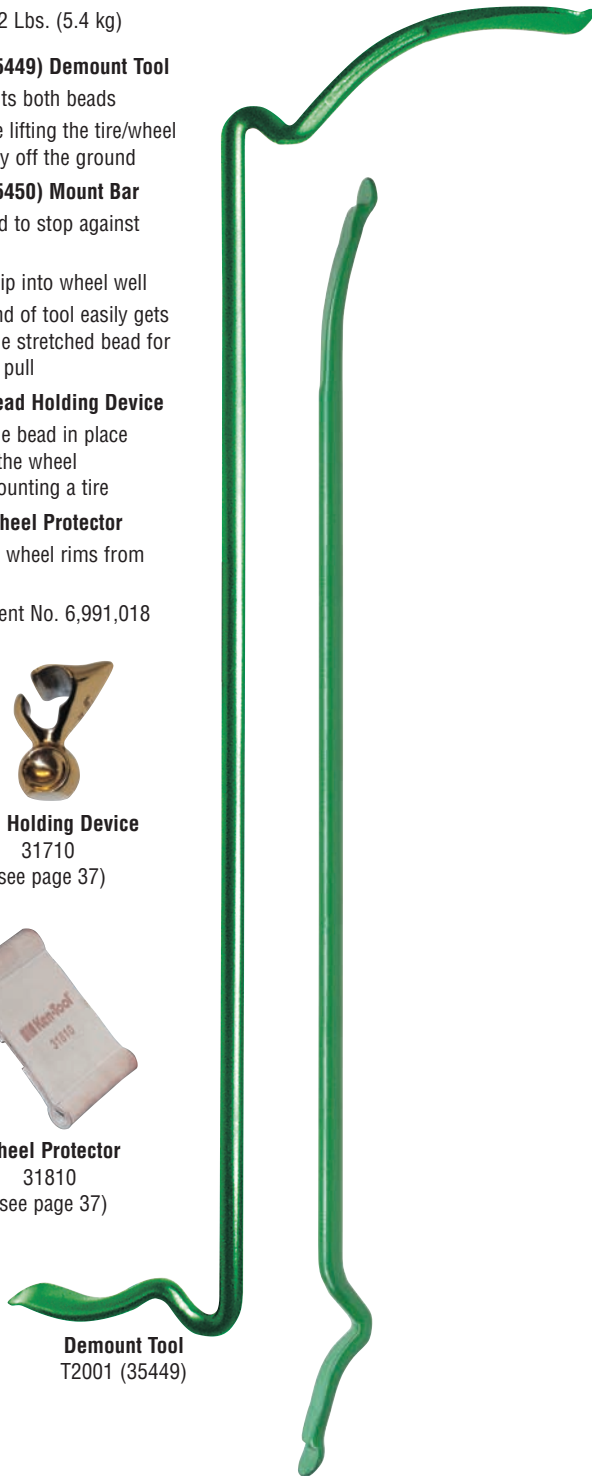

Demount Tool
T2001 (35449)

Mount Tool
T2002 (35450)



TIRE CHANGING SETS
JUEGOS PARA CAMBIAR LLANTAS
ENSEMBLES DE CHANGEMENT DE PNEU

*Simple,
Easy,
Quick!*

*Revolutionary new designs
take the struggle out of
mounting and demounting
truck tires*

**UNIQUE MOUNT &
DEMOUNT TOOLS:**

SERPENT TOOLS

SUPER SERPENT TOOLS

SERPENT TOOL SETS

*Ken-tool offers a complete line of
mount / demount tire irons
~ see pages 35, 36, 37 ~*

NEW

SUPER Tires Need SUPER Tools!

Finally! Tools specially designed to handle big, big tires that actually work! Now, mounting and demounting the biggest, heaviest truck tire is made easy. Our tools don't have to be super big and heavy to handle the tires that are.

These powerful tools are single-piece constructions, forged from high-grade carbon steel, and fully heat-treated for strength and long-lasting durability. We've even modified the bead holders, to "reach over" the extra wide band, and guide it under the rim.

Super Serpent™ Mount Tool

*Herramienta para montar
Outil d'assemblage*

This mount tool for super singles only weighs about 6-1/2 pounds. It may seem "funny-looking", but every inch of this innovative design is purely serious. It makes interference of the second bead, while mounting the first, a thing of the past, and delivers **twice** the leverage of **any** "straight-type" tire mounting tool. It even has the small end that easily gets under the bead for that "last pull".

- Length: 37" (94 cm)
- Stock: 3/4" (19 mm)

	Model	EDP No.	Weight
NEW	T2005	35447	6.6 lbs. (3 kg)

Patent Pending

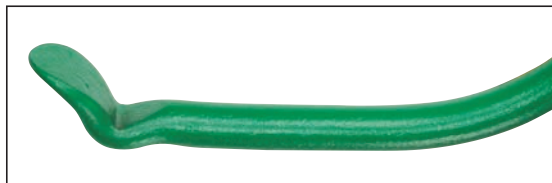
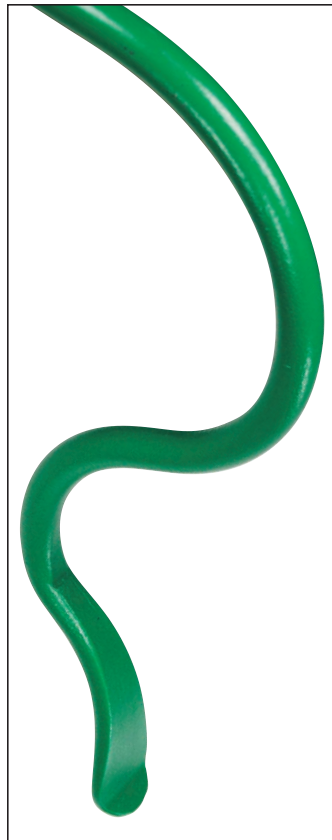

Super Serpent™ 5 Pc. Tire Changing Set

Juego de 5 piezas para cambiar llantas

Ensemble 5 pièces de changement de pneu

NEW Set No. 35446
Weight: 19 Lbs. (8.6 kg)



2 Bead Holding Devices
31710
(see page 37)



Wheel Protector
31810
(see page 37)



Super Serpent™ Demount Tool

Herramienta de desmontaje

Outil de démontage

Weighing in at only 5-1/2 pounds, this unique, lightweight demount tool for super singles can be lugged around on a fingertip, yet delivers the incredible leverage, right where it's needed, to easily pop those heavyweights right off their wheels.

- Length: 37" (94 cm)
- Stock: 3/4" (19 mm)

Model	EDP No.	Weight
T2006	35448	5.5 lbs (2.5 kg)

NEW

Patent Pending

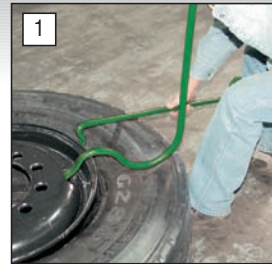

Four-Way Lug Wrenches

Llaves cruz

Clés à goujon à quatre têtes

Ken-Tool offers the world's largest selection of quality lug wrenches, available in sizes to fit all your tire changing needs - SAE and Metric.

Professional Lug Wrenches

Llaves profesionales

Clés à goujon professionnelles



These wrenches are America's premier professional lug wrenches for cars, light trucks, SUV's, RV's, and vans. Drop-forged centers for extra strength. Keep wrenches in trunk for emergencies or everyday use.

Model	EDP No.	Description	Socket Sizes	Length	Stock	Weight
T56	35656	Passenger	17, 19, 21, 22 mm	20" 51 cm	5/8" 16 mm	4 lbs 1.8 kg
T57®	35657	Passenger	3/4", 13/16", 7/8", 15/16"	23" 58 cm	5/8" 16 mm	4.5 lbs 2.0 kg

Standard Lug Wrenches

Llaves estándar

Clés à goujon standard

Welded center construction for strength and durability. Premium grade, special bar quality steel for extra strength.



Model	EDP No.	Description	Socket Sizes	Length	Stock	Weight
T59	35659	Passenger	3/4", 13/16", 7/8", 15/16"	22" 56 cm	5/8" 16 mm	4.2 lbs 1.9 kg
T90	35690	Light Truck	7/8" deep well, 15/16", 1", 1-1/16"	25" 64 cm	3/4" 19 mm	7.2 lbs 3.2 kg

Economy Lug Wrenches

Llaves económicas

Clés à goujon économiques

These wrenches have fully welded centers which stand up to everyday use. 3/4" SAE is also 19 mm.

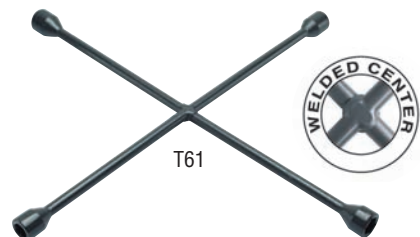

Model	EDP No.	Description	Socket Sizes	Length	Stock	Weight
T9520	35620	Passenger	3/4", 13/16", 7/8", 17 mm	20" 51 cm	9/16" 14 mm	3.4 lbs 1.5 kg
T61	35661	Passenger	3/4", 13/16", 7/8", 17 mm	22" 56 cm	9/16" 14 mm	3.8 lbs 1.7 kg
T62	35662	Passenger	3/4", 13/16", 7/8", 17 mm	18" 46 cm	9/16" 14 mm	3.2 lbs 1.5 kg
T63	35663	Passenger	17, 19, 21, 22 mm	18" 46 cm	9/16" 14 mm	3.2 lbs 1.5 kg

Heavy-Duty Truck Lug Wrenches

Llaves para camiones de alta resistencia

Clés à goujon pour camions lourds

Use on heavy-duty trucks, buses, and tractors. Drop-forged or welded center provides strength and durability. **T95**, **TM95**, **T95A**, and **TC95** wrenches have center hole for a leverage bar. Socket sizes provided fit most metric or SAE lug nuts on today's trucks. Stock: 1" (25 mm).



Model	EDP No.	Socket Sizes	Length	Weight
T95	35695	1-1/16", 1-1/4", 1-1/2", 13/16" square	27-1/2" 70 cm	13.8 lbs 6.2 kg
TM95	35795	24, 27, 30, 33 mm	27-1/2" 70 cm	13.5 lbs 6.1 kg

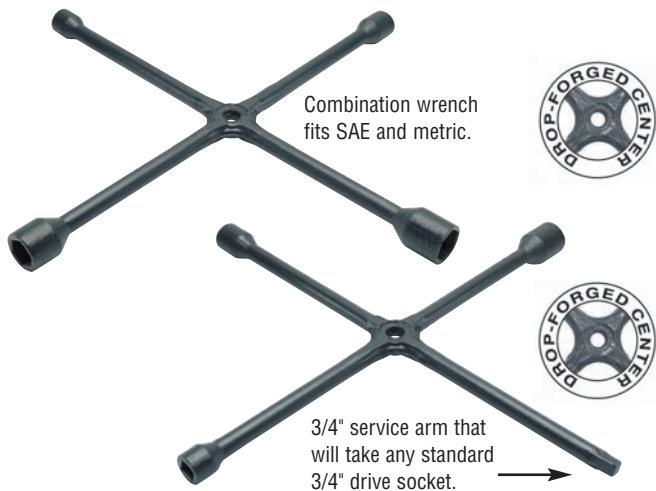

Model	EDP No.	Socket Sizes	Length	Weight
TC95	35595	1-1/2", 13/16" square, 30, 33 mm	27-1/2" 70 cm	14.2 lbs 6.4 kg
T95A	35697	1-1/4", 1-1/2", 13/16" sq., 3/4" service arm	27-1/2" 70 cm	13.5 lbs 6.1 kg



Model	EDP No.	Socket Sizes	Length	Weight
T96	35696	1-1/16", 1-1/4", 1-1/2", 13/16" square	27-1/2" 70 cm	13.5 lbs 6.1 kg

Double-End Truck Wrenches

Llaves dobles para camiones

Clés à double tête pour camions



Use on trucks, buses, farm, and off-road vehicles. Great for on-the-road service. Sizes available for all SAE and metric lug nuts. All wrenches are forged from 1" alloy steel for long lasting strength. Length: 16" (41 cm). Use **TR5** truck wrench handle.

SAE • SOCIEDAD DE INGENIEROS AUTOMOTRICES (SAE)

Model	EDP No.	Sockets Sizes	Weight
TR1	32501	1-1/8" with 13/16" Sq. x 1-1/2"	4.6 lbs (2.0 kg)
TR2	32502	1" with 5/8" Sq. x 1-1/4"	4.3 lbs (1.9 kg)
TR3	32503	7/8" x 1-1/16"	4.5 lbs (2.0 kg)
TR3A	32505	1-1/16" x 1-1/8"	4.5 lbs (2.0 kg)
TR3X	32506	1-1/16" x 1-3/16"	4.5 lbs (2.0 kg)
TR98	32508	1-1/2" x 13/16" Sq.	4.5 lbs (2.0 kg)
TR9	32509	1-1/4" x 1-1/16"	4.4 lbs (2.0 kg)

METRIC • MÉTRICO • MÉTRIQUE

Model	EDP No.	Sockets Sizes	Weight
TRM1	32551	17 mm sq. x 35 mm	4.5 lbs (2.0 kg)
TRM2	32552	24 mm x 33 mm	4.4 lbs (2.0 kg)
TRM3	32553	27 mm x 30 mm	4.5 lbs (2.0 kg)
TRM6	32556	21 mm sq. x 41 mm	4.5 lbs (2.0 kg)
TRM7	32557	30 mm x 33 mm	4.5 lbs (2.0 kg)

Truck Wrench Handle

Mango de llave para camiones

Manche de clé pour camions



Heat-treated for strength and durability. Fits all Ken-Tool Double-end truck wrenches

Model	EDP No.	Length	Stock	Weight
TR5	32318	22" (56 cm)	3/4" Hex	2.7 lbs (1.2 kg)

Heavy-Duty Truck Wrench

Llaves para camiones de alta resistencia

Clé robuste pour camions



Use for off-the-road Budd-type wheels. Use **TR11** handle. Long length provides extra leverage. Stock: 1-1/4" (3.1 cm)

Model	EDP No.	Length	Socket Size	Weight
TR10	34401	29-1/2" (75 cm)	1-3/4" Hex & 15/16" sq.	12.2 lbs (5.5 kg)
TR11	34402	30" (76 cm)		6.5 lbs (2.9 kg)

Wrench Support Stand

Base de soporte para llave

Support de soutien pour clé

Commercial-duty stand used to support a double-end truck wrench, a 4-way lug wrench, or a torque wrench, when removing or replacing lug nuts. Adjusts from 14-1/2" to 22-1/2" high.



Model	EDP No.	Weight
32610	32610	5.5 lbs (2.5 kg)

Ken-Tool®

TIRE SERVICE TOOLS & EQUIPMENT, & SPECIALTY TOOLS
HERRAMIENTAS PARA REPARAR LLANTAS, EQUIPO Y HERRAMIENTAS ESPECIALIZADAS
OUTILS D'ENTRETIEN DE PNEU, ÉQUIPEMENT ET OUTILS SPÉCIAUX

World Class Quality

A COMPLETE LINE OF TIRE CHANGING TOOLS:
WRENCHES • BEAD BEAKERS
LOCK RING TOOLS
MOUNT / DEMOUNT TOOLS
HAMMERS & HANDLES
TIRE SERVICE TOOLS
SOCKETS • INFLATION CAGES
SMALL TIRE SERVICE TOOLS
SHOP SERVICE TOOLS

Over 80 years dedication to research, manufacturing, customer service, & shipping excellence combine to give you the best made tire changing products in the world

Power Wrench

Llave eléctrica
Clé à chocs



Designed for dual nut systems. Has 13/16" sq. end to hold inner nut, with a 1-1/2" hex drive to spin outer nut off. Also adaptable to remove any nut size with a **TR55** adapter. 3-to-1 ratio provides mechanical power advantage necessary to remove any stubborn nut found on trucks, farm vehicles, buses, aircraft, and RV's. Tremendous power allows one man operation. Heat-treated portable components for extra strength. All sockets are 3/4" drive.

**TR43 (34543) Basic Power Wrench Set**

Juego de llaves eléctricas básicas

Jeu de clés à chocs de base

Weight: 19 lbs. (8.6 kg)

Set contains: **Power Drive**

TR45 20-1/2" (52 cm) Bar Hdle. **TR46** 20" (51 cm) Tube Hdle.

TR44X (34545) Budd-Wheel Power Wrench Set

Juego de llaves eléctricas para ruedas tipo Budd

Jeu de clés à chocs pour roues à disque

The 3/4" service adapter allows you to use any 3/4" drive socket.

Drive end is 1-1/2" hex. 13/16" square adapter for inner nut.

Weight: 20 lbs. (9.1 kg)

Set contains: **Power Drive**

TR45 20-1/2" (52 cm) Bar Hdle. **TR52** 13/16" Sq. Adapter
TR53 36" (91 cm) Tube Hdle. **TR55** 3/4" Service Adapter

TR44SW (34547) Universal Power Wrench Set

Juego de llaves eléctricas universales

Jeu de clés à chocs universelles

Weight: 29 lbs. (13.2 kg)

Set contains: **Power Drive**

Impact sockets: **TR45** 20-1/2" (52 cm) Bar Hdle.
S20 7/8" **S24** 1-1/8" **TR53** 36" (91 cm) Tube Hdle.
S21 15/16" **S25** 1-3/16" **TR52** 13/16" Square Adapter
S23 1-1/16" **S33** 33 mm **TR55** 3/4" Service Adapter

Have a new idea?
E-mail sales@kentool.com

Shock Wrench

Llave de amortiguación
Clé pour amortisseurs



Shaft has 3/4" square drive end to accept 3/4" impact sockets and a 13/16" square socket. Heat-treated shaft for extra strength. Loosens or tightens stubborn lug nuts by 120° arc impact of arm rotating on shaft. Will not strip threads or bend lugs.

- TR41 (34441) Standard Shock Wrench Set**

Juego de llaves de amortiguación estándar

Jeu de clés standard pour amortisseurs

Weight: 25.3 lbs. (11.5 kg)

Set contains: **Impact Sockets:**

S20 7/8" **S24** 1-1/8" **TR7** Handle
S21 15/16" **S25** 1-3/16" **TR8** Shaft
S23 1-1/16" **S27** 1-1/2" **TX9** Cap Nut Wrench
Metal box

- TR42 (34442) Budd Wheel Shock Wrench Set**

Juego de llaves de amortiguación tipo Budd

Jeu de clés pour amortisseur de roues à disque

Weight: 23.5 lbs. (10.7 kg) (Not illustrated)

Set contains: **S27** 1-1/2" Impact socket

TR7 Handle **TR8** Shaft
TX9 Cap nut wrench
Metal box

Dual Wheel Lug Stud Remover

Desmontador de tuercas para ruedas dobles

Extracteur de goujons de roues de camions à prise double

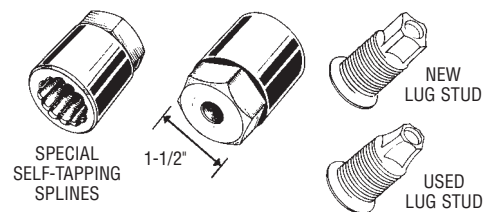
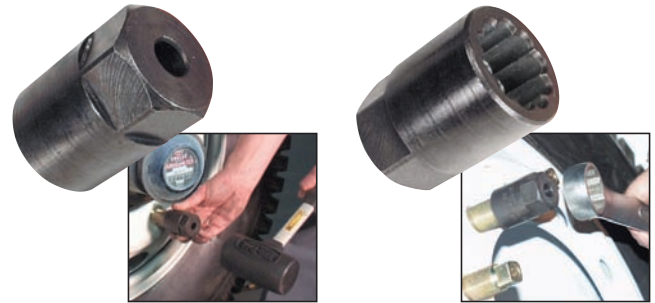

Special self-tapping splines provide maximum grip to remove stripped lug studs. Use with **TR1**, **TR98** truck wrenches. Can also be used with an open end wrench. Use with soft faced hammer. (see pg. 13)

Model	EDP No.	Description	Weight
30165	30165	Fits 13/16" sq. inner nut	1 lb (.5 kg)

Cap Nut Wrenches

Llaves de tuercas ciegas
Clés à écrou borgne

Ken-Tool Porkchop™



Wrenches hold outer cap nut on dual wheels while the inner nut is turned. Lip fits in hole to secure wrench in place. Sizes offered fit standard and metric cap nuts.

Model	EDP No.	Description	Size	Weight
TX9°	30609	SAE	1-1/2"	.73 lbs (.3 kg)
TX10	30610	Metric	35 mm	.4 lbs (.1 kg)
TX12	30612	Metric	41 mm	.4 lbs (.1 kg)

Combination Cap Nut Wrench

Llave de tuercas ciegas de combinación
Clé à écrou borgne deux en un



Offers the versatility of two wrenches in one unique product design. Fit one end onto the outer cap nut with the other end through the center hole. Wrench slides underneath center disc of wheel, reducing slipping during nut removal.

Model	EDP No.	Description	Size	Weight
TX50	30620	SAE & Metric	41 mm, 1-1/2"	1.3 lbs (1.0 kg)

Heavy-Duty Cap Nut Wrenches

Llaves de tuercas ciegas de alta resistencia
Clés robustes à écrou borgne



U.S. Patent no. D446,429

Heavy-duty design will not slip out of position. Wrench rests snugly against the center hole, reducing the possibility of rim damage. Ideal for aluminum wheels.

Model	EDP No.	Description	Size	Weight
TX200	30618	SAE	1-1/2"	2.6 lbs (1.2 kg)
TX241	30619	Metric	41 mm	2.6 lbs (1.2 kg)

Wheel Cover Puller / Replacers

Extractor/cambiadores de cubiertas
Extracteur de garde-roues/garde-roues d'échange

Removes wheel covers quickly and easily without gouging or scratching them. Rubber head T11RH prevents damage to hub cap and is replaceable.



Pro

Profesional
Professionnel



Model	EDP No.	Length	Stock	Weight
T67	31567	17-1/2" (45 cm)	9/16" (14.3 mm)	1.8 lbs (.8 kg)

Standard

Estándar
Standard



Model	EDP No.	Length	Stock	Weight
T68°	31568	14" (36 cm)	7/16" (11.1 mm)	1.3 lbs (.6 kg)

Center Cap Removers

Desmontadores de tapas centrales
Extracteur de chapeau centrale

Wide Blade

Paleta ancha
Lame large

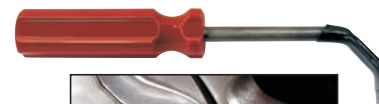

Removes larger center covers without damaging wheels.

Model	EDP No.	Length	Stock	Weight
NEW T65	31565	7-3/4" (19.6 cm)	5/16" (7.9 mm)	.2 lbs (.09 kg)

Narrow Blade

Paleta angosta
Lame étroite



Removes small delicate center covers without wheel damage.

Model	EDP No.	Length	Stock	Weight
NEW T66	31566	7-3/4" (19.6 cm)	5/16" (7.9 mm)	.2 lbs (.09 kg)

Two Piece Center Cap Remover Set

Equipo de dos desmontadores de tapas centrales
Ensemble (2 pc) chapeau centrale de pneu

Set consists of: No. T65 (31565), No. T66 (31566).

Model	EDP No.	Description	Weight
NEW 31564	31564	2 Pc. Center Cap Remover Set	.5 lbs (.22 kg)

Torque Master Torque Limiting Sockets

Llaves de tubo limitadoras del par motor principal

Douilles de limitation de couple Torque Master

For foreign and domestic cars and light trucks. Tighten nuts to factory specifications each time the wheels are replaced. Color and letter coded for quick size and torque reference. Converts any impact gun, including those with an extended anvil, into an instant torque wrench by bleeding torque off the impact gun. Application chart can be wall mounted. (Application chart No. 30199, is also available separately.) One year warranty.



Four Piece Starter Kit

Equipo básico de cuatro piezas

Ensemble de base de quatre pièces

Set contains:

30181, 30183, 30185, 30189

Model	EDP No.	Weight
30174	30174	4.4 lbs (2.0 kg)



Six Piece Starter Kit

Equipo básico de seis piezas

Ensemble de base de six pièces

Set contains:

30181, 30183, 30184, 30185, 30186, 30189

Model	EDP No.	Weight
30176	30176	6.5 lbs (3.0 kg)



Nine Piece Kit

Equipo de nueve piezas

Ensemble de neuf pièces

Set contains:

30181, 30182, 30183, 30184, 30185, 30186, 30187, 30188, 30189

Model	EDP No.	Weight
30179	30179	8.4 lbs (3.8 kg)

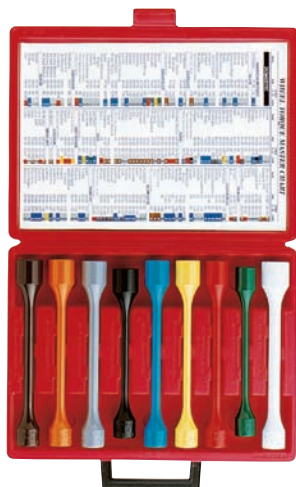

Four Piece Torque Stick Set for SUV's

Most Popular Sizes for Largest Growing Market
Juego de palancas de par motor de cuatro piezas para los tamaños más populares de vehículos todo terreno para el mayor mercado en crecimiento

Ensemble de quatre bras de torsion convenant aux VUS de dimensions les plus populaires idéal pour un marché de plus en plus grand

For domestic and foreign SUV's. Tighten lug nuts to factory specifications. Color and letter coded for quick size and torque reference.

Set contains:

- 30181** - Brown (A) 100 ft/lbs.
- 30183** - Gray (C) 100 ft/lbs.
- 30200** - Aqua (Q) 140 ft/lbs.
- 30204** - Turquoise (BB) 150 ft/lbs.

Model	EDP No.	Weight
30175	30175	4.5 lbs (2 kg)



Four Piece Extension Kit for Passenger Car - 1/2" Drive

Juego de extensión de cuatro piezas para automóviles de pasajeros – entrada de 1/2 pulgada

Ensemble de rallonge de quatre pièces pour automobiles - Prise 1/2 po

Extension kit to be used on passenger vehicles. Convert your own sockets into torque sockets.

Set contains:

- 30223** - Gray (C) 100 ft/lbs
- 30225** - Blue (E) 80 ft/lbs
- 30226** - Yellow (F) 65 ft/lbs
- 30229** - White (I) 120 ft/lbs

Model	EDP No.	Weight
30234	30234	3 lbs (1.3 kg)



Individual Sockets (1/2" Drive)

Llaves de tubo individuales (entrada de 1/2 pulgada)

Douilles individuelles (Prise 1/2 po)



Model	Description	Socket Opening	Torque Limit	Weight
30181	Brown (A)	13/16"	100 ft / lbs	.5 lbs (.2 kg)
30182	Orange (B)	21 mm	80 ft / lbs	.5 lbs (.2 kg)
30183	Gray (C)	19 mm (3/4")	100 ft / lbs	.5 lbs (.2 kg)
30184	Black (D)	21 mm	60 ft / lbs	.5 lbs (.2 kg)
30185	Blue (E)	19 mm (3/4")	80 ft / lbs	.5 lbs (.2 kg)
30186	Yellow (F)	19 mm (3/4")	65 ft / lbs	.5 lbs (.2 kg)
30187	Red (G)	17 mm	80 ft / lbs	.5 lbs (.2 kg)
30188	Dark Green (H)	17 mm	45 ft / lbs	.5 lbs (.2 kg)
30189	White (I)	7/8"	120 ft / lbs	.5 lbs (.2 kg)
30195	Tan (J)	1"	140 ft / lbs	.5 lbs (.2 kg)
30196	Purple (K)	17 mm	110 ft / lbs	.5 lbs (.2 kg)
30197	Lt Green (L)	1"	170 ft / lbs	.5 lbs (.2 kg)
30198	Maroon (V)	1-1/16"	140 ft / lbs	.5 lbs (.2 kg)
30200	Aqua (Q)	7/8"	140 ft / lbs	.5 lbs (.2 kg)
30201	Lime Green (T)	15/16"	135 ft / lbs	.5 lbs (.2 kg)
30202	Dark Blue (Y)	22 mm	100 ft / lbs	.5 lbs (.2 kg)
30203	Beige (Z)	7/8"	65 ft / lbs	.5 lbs (.2 kg)
30204	Turquoise (BB)	21 mm	150 ft / lbs	.5 lbs (.2 kg)
30199	Application Chart			

Individual Heavy-Duty Truck Torque Extensions

Extensiones de par motor individuales

de alta resistencia para camiones

Rallonges individuelles robustes

de torsion pour camions



Convert your own sockets into torque sockets for use on commercial, heavy-duty trucks, and buses.

Model	Description	Drive Size Socket/Opening	Torque Limit	Weight
30230	Yellow (O)	3/4"	175 ft / lbs	.75 lbs (.3 kg)
30231	Yellow (N)	3/4"	250 ft / lbs	.75 lbs (.3 kg)
30232	Yellow (U)	3/4"	350 ft / lbs	.75 lbs (.3 kg)
30233	Yellow (M)	3/4"	475 ft / lbs	.75 lbs (.3 kg)
30236	Yellow (T)	1"	175 ft / lbs	1 lb (.5 kg)
30237	Yellow (R)	1"	250 ft / lbs	1 lb (.5 kg)
30238	Yellow (S)	1"	350 ft / lbs	1 lb (.5 kg)
30239	Yellow (P)	1"	475 ft / lbs	1 lb (.5 kg)
30240	Yellow (W)	1"	650 ft / lbs	1 lb (.5 kg)

WARNING: Torque sockets and truck torque extensions cannot be used to take off wheel nuts. Calibrate your impact gun and follow all manufacturers' recommended procedures when using Torque Master products.

**Always wear safety goggles
when using hand tools**

Bead-Breaking Tools Truck / Farm / OTR

Herramientas desmontadoras de llantas para camiones/vehículos de granja/de carretera

Outils de décollage des talons pour camions/tracteurs/véhicules tout terrain



33341

These lightweight, portable tools are a great alternative to handled bead breaking wedges or hydraulic bead breakers. One end is used to remove frozen or rusted beads from all types of rims. On the T52, the other end can be used as a leverage bar when inserted into the 35695 or 35697 Truck Lug Wrench.

Swan Neck Leverage Bar

Palanca de cuello de cisne

Barre de levage à col de cygne



Model	EDP No.	Length	Stock	Weight
T41	33341	30" (76 cm)	7/8" (22 mm)	5.3 lbs (2.4 kg)

30" Bead Breaker

Desmontadora de llantas de 30 pulgadas

Démonte-talons de 30 po



Model	EDP No.	Length	Stock	Weight
T42	33342	30" (76 cm)	7/8" (22 mm)	4.8 lbs (2.2 kg)

Bead Breaker Leverage Bar

Palanca desmontadora de llantas

Barre de levage pour démonte-talons



Also for use with the T95 wrenches.

Model	EDP No.	Length	Stock	Weight
T52	34652	33" (84 cm)	7/8" (22 mm)	5.5 lbs (2.5 kg)

Portable Bead Breaker

Desmontadora de llantas portátil

Démonte-talons portatif



Portable bead-breakers are great for custom and foreign wheels. They break beads on most sizes of passenger tires and light trucks.

Model	EDP No.	Handle Length	Weight
T100	34670	36" (91 cm)	5.2 lbs (2.3 kg)

Bead-Breaking Tool / Driving Iron

Herramienta desmontadora de llantas/barra de hierro desmontadora

Outil de décollage des talons/Levier d'entraînement

Driving iron is used for loosening rusted truck and bus beads. Will speed truck tire repair work and save labor and time.



Model	EDP No.	Length	Stock	Weight
T26A	32126	11-3/4" (30 cm)	1-1/4" (32 mm)	4.4 lbs (2.0 kg)

Impact Bead Breakers

Desmontadoras de llantas de impacto
Démonte-talons à chocs

Bead breaker loosens beads with bead-breaking foot and ram bar, but never cuts the bead of the tire. The wedge foot is forced between the bead and rim flange. Breaker is designed for shop or road use. No other bead breaking tools are necessary. Provides greater accuracy than other conventional bead breakers.



T26B has exclusive spring action design to reduce user fatigue associated with slide hammer kickback.

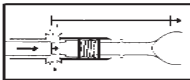

Model	EDP No.	Description	Length	Length Extended	Weight
T26B	35926	Heavy-duty	50" 127 cm	80" 203 cm	23 lbs 10.4 kg



Model	EDP No.	Description	Length	Length Extended	Weight
T24B	35924	Economy	46" 117 cm	72" 183 cm	13.5 lbs 6.1 kg

Floor Type Bead Breakers

Desmontadoras de llantas con pie
Démonte-talons sur sol

Ideal for stubborn tires. Use to prevent the bending of wheels. A great solution for custom and foreign wheels.



Model	EDP No.	Description	Tread Width	Weight
T99B	35999	Standard	up to 8" (20 cm)	28.5 lbs (12.9 kg)



Model	EDP No.	Description	Tread Width	Weight
T98	35998	Deluxe	up to 11" (28 cm)	29.8 lbs (13.5 kg)

Lock Ring Tools

Herramientas para anillos de seguridad
Outils pour anneau verrouilleur

These tools are designed to remove most truck lock rings. A must-have for anyone mounting or demounting multi-piece rims. Use in pairs.

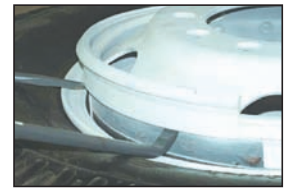
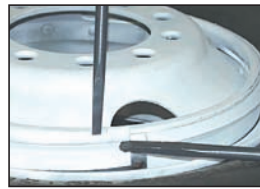

Truck Lock Ring Remover

Desmontador para anillos de seguridad para camiones
Dégageur d'anneau verrouilleur pour camions



Designed for smaller diameter wheels.

Model	EDP No.	Length	Stock	Weight
T23®	32123	24" (61 cm)	11/16" (17.5 mm)	2.4 lbs (1.0 kg)

Truck Lock Ring Remover

Desmontador para anillos de seguridad para camiones
Dégageur d'anneau verrouilleur pour camions



Designed for smaller diameter wheels.

Model	EDP No.	Length	Stock	Weight
T23A®	33223	30" (76 cm)	11/16" (17.5 mm)	3.1 lbs (1.4 kg)

Combination Rim / Ring Tool

Herramienta para combinación de llantas/anillos
Deux en un pour jante/anneau



Flat tapered end ideal for all around ring and rim work.

Model	EDP No.	Length	Stock	Weight
T23B	33224	23-1/2" (60 cm)	11/16" (17.5 mm)	2.4 lbs (1.0 kg)

Rim Lock Tool

Herramienta para anillos de seguridad de llantas
Bloque-talons



For servicing wide base rims.

Model	EDP No.	Length	Stock	Weight
T25	32125	18" (46 cm)	11/16" (17.5 mm)	1.8 lbs (.8 kg)

Special Lock Ring Tool

Herramienta para anillos de seguridad especiales
Outil spécial pour anneau verrouilleur



Long tapered curved end for continuous side rings.

Model	EDP No.	Length	Stock	Weight
T27	32127	18" (46 cm)	11/16" (17.5 mm)	1.8 lbs (.8 kg)

Lock Ring Tool

Herramienta para anillos de seguridad
Outil pour anneau verrouilleur



Removes continuous side rings on two-piece truck rims.



Model	EDP No.	Length	Stock	Weight
T27A	32128	18" (46 cm)	11/16" (17.5 mm)	1.8 lbs (.8 kg)

Heavy-Duty Lock Ring Tool

Herramienta para anillos de seguridad de alta resistencia

Outil robuste pour anneau verrouilleur



Use for multi-piece wheels, especially hub type.

Model	EDP No.	Length	Stock	Weight
T48A	34648	37" (94 cm)	3/4" (19 mm)	4.6 lbs (2.1 kg)

Small Tire Mount/Demount Irons

Barras para montaje/desmontaje de llantas pequeñas

Leviers de montage/démontage de petits pneus

New designs are based on popular European styles. Extended length of the flat curved sliding surface provides mounting ability comparable to much longer traditional tire irons. Sizes available for motorcycle, passenger, truck, and heavy-duty tires. Designed for mounting and demounting tires. Best if used in pairs.



Motorcycle / Small Wheel

Ruedas pequeñas/de motocicleta

Motocycllette / Petites roues



Model	EDP No.	Length	Stock	Weight
T43A	39805	15" (38 cm)	3/4" (19 mm)	1.8 lbs (.8 kg)

Mount / Demount Tire Tools - Small Tire

Herramientas para montaje y desmontaje de llantas - Llantas pequeñas

Outils de montage/démontage de pneus - Petits pneus



Tools are used in pairs to mount or demount small passenger, industrial, ATV, and motorcycle tires.

Model	EDP No.	Length	Stock	Weight
T6A	32106	16-1/2" (42 cm)	5/8" (16 mm)	1.5 lbs (.7 kg)

Tire Irons - Small Tire

Barras para llantas - Llantas pequeñas
Démonte-pneus - Petits pneus



Pro tire changing tools for small tires. Ideal for mounting and demounting motorcycle, ATV, lawn tractor, golf cart, and small tires by hand. Rounded ends will not pinch tube. Patented.

Model	EDP No.	Length	Stock	Weight
T9A	32109	9" (23 cm)	7/16" (11 mm)	.4 lbs (.16 kg)
T16A	32116	16" (41 cm)	7/16" (11 mm)	.7 lbs (.3 kg)
T9C	32110	2 pc. Carded Set - Contains 2 T9A 9" Bars		
T16C	32117	2 pc. Carded Set - Contains 2 T16A 16" Bars		

Tire Irons - Small Tire

Barras para llantas - Llantas pequeñas
Démonte-pneus - Petits pneus



Pro tire changing tools for small tires. Sturdy, comfortable plastic handles. Ideal for mounting and demounting motorcycle, ATV, lawn tractor, golf cart, and small tires by hand. Rounded ends will not pinch tube.

Model	EDP No.	Length	Stock	Weight
T5	32115	16" (41 cm)	7/16" (11 mm)	.8 lbs (.36 kg)
T8	32118	16" (41 cm)	7/16" (11 mm)	.8 lbs (.36 kg)

Two Piece Small Tire Iron Set

Equipo de dos barras para llantas pequeñas

Ensemble petit barre à pneu (2 pcs)

Set consists of: No. T5 (32115), No. T8 (32118).

Model	EDP No.	Description	Weight
32114	32114	2 Pc. Small Tire Iron Set	1.6 lbs (.7 kg)

Super Single Tire Mount / Demount Tool

Herramienta individual especial para montaje/desmontaje de llantas

Super outil de montage/démontage en une seule pièce

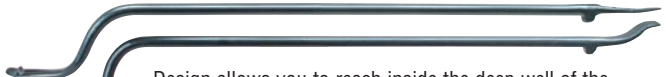

T45DX Design allows you to reach inside the deep well of the tire to pull the bead over the rim. Patented one-piece manufacturing process assures long life and superior performance. Use with T45DX. Use on 16.5" x 22.5" duplex and rear tractor tires.



Model	EDP No.	Length	Stock	Weight
T45SX	34945	50" (127 cm)	7/8" (22 mm)	9.3 lbs (4.2 kg)

U.S. Patent No's 348,595 and 5,343,921

Use on 16.5" x 22.5" duplex and 25" solid wheel loader tires. Patented one-piece manufacturing process assures long life and superior performance. Use with T45SX.

Model	EDP No.	Length	Stock	Weight
T45DX	34946	50" (127 cm)	7/8" (22 mm)	8.5 lbs (3.9 kg)

U.S. Patent No's 348,595 and 5,343,921

European Style Tools

Herramientas de estilo europeo

Outils de style européen

Use on car, motorcycle, truck, and agricultural tires. Designed for mounting and demounting tires.

Best if used in pairs.



Model	EDP No.	Length	Stock	Weight
T43C	39806	21" (53 cm)	7/8" (22 mm)	3.1 lbs (1.4 kg)



Model	EDP No.	Length	Stock	Weight
T43D	39810	30" (76 cm)	7/8" (22 mm)	4.5 lbs (2.0 kg)



Model	EDP No.	Length	Stock	Weight
T44	39808	31" (79 cm)	7/8" (22 mm)	5.3 lbs (2.4 kg)

T44 illustration



Cross Reference:

Ken-Tool No.	T43A	T43C	T43D	T44	T45SX	T45DX	T41
CPM	Livraison Ref. 1547	Face 68 Ref.426/68	Force Ref. 1289	Halte Ref. 1060	Hyoca Ref. 1194	Hyude Ref. 1195	Sayam Ref. 858

Tire Mount / Demount Spoons

Espátula para montaje/desmontaje de llantas

Cuillères de montage/démontage de pneus

These tools are designed for fast and efficient tire changing. Use the 18" and 24" spoons to mount or demount passenger car, motorcycle, ATV, and light truck tires. The 30" spoons provide enough strength and leverage to work on large truck, bus, off-road vehicle, tractor, and aircraft tires.

Mount



Demount



Straight • Recta • Droit

Model	EDP No.	Length	Stock	Weight
T1X	32101	18" (46 cm)	11/16" (17.5 mm)	1.8 lbs (.8 kg)
T19	32119	24" (61 cm)	11/16" (17.5 mm)	2.5 lbs (1.1 kg)
T19A	33219	30" (76 cm)	11/16" (17.5 mm)	3 lbs (1.4 kg)
T38	33238	30" (76 cm)	7/8" (22 mm)	4.8 lbs (2.2 kg)



Drop-Center • Con base con caída • A centre base

Model	EDP No.	Length	Stock	Weight
T21R	32121	18" (46 cm)	11/16" (17.5 mm)	1.8 lbs (.8 kg)
T21F	34121	24" (61 cm)	11/16" (17.5 mm)	2.5 lbs (1.1 kg)
T21HD	34122	30" (76 cm)	7/8" (22 mm)	4.5 lbs (2.0 kg)



Curved • Curva • Cuvée

Model	EDP No.	Length	Stock	Weight
T2X	32102	18" (46 cm)	11/16" (17.5 mm)	1.8 lbs (.8 kg)
T20	32120	24" (61 cm)	11/16" (17.5 mm)	2.4 lbs (1.1 kg)
T20A	33220	30" (76 cm)	11/16" (17.5 mm)	3.1 lbs (1.4 kg)
T39	33239	30" (76 cm)	7/8" (22 mm)	4.5 lbs (2.0 kg)



Tubeless Tire Irons & Sets

Juegos y barras para llantas sin cámara

Démonte-pneus individuels & en ensemble pour pneus sans chambre à air



T46A, T47A



T46B, T47B



T46C, T47C



T47A end

Sets provide all irons necessary for a variety of tire changing applications. Use "C" bar with the "B" extension bar for easier use on large, wide-base truck tires. Use on standard and large truck tires, including industrial, farm, buses, and tractors.

Standard • Estándar • Standard

Model	EDP No.	Description	Length	Stock	Weight
T46	34746	Tire Iron Set includes: T46A,T46B,T46C		3/4" 19 mm	12 lbs 5.4 kg
T46A	34747	Straight Mount/Demount Tool	36" 91 cm	3/4" 19 mm	4.5 lbs 2.0 kg
T46B	34748	Straight Mount/Demount Tool "B" Extension for T46C	36" 91 cm	3/4" 19 mm	4.5 lbs 2.0 kg
T46C	34749	Offset Mount "C" Bar	22" 56 cm	3/4" 19 mm	3 lbs 1.4 kg

Heavy-Duty • De alta resistencia • Robuste

Model	EDP No.	Description	Length	Stock	Weight
T47	34846	Tire Iron Set includes: T47A,T47B,T47C		1" 25 mm	29 lbs 13.1 kg
T47A	34847	Straight Mount/Demount Tool	52" 132 cm	1" 25 mm	11 lbs 5.0 kg
T47B	34848	Straight Mount/Demount Tool "B" Extension for T47C	49-1/2" 126 cm	1" 25 mm	11 lbs 5.0 kg
T47C	34849	Offset Mount "C" Bar	27" 69 cm	1" 25 mm	6.6 lbs 3.0 kg

Mounting



Demounting



Tubeless Truck Tire Mount / Demount Irons

Barras para montaje/desmontaje de llantas de camiones sin cámara

Démonte-pneu de montage/démontage pour pneus de camion sans chambre à air

Ken-Tool manufactures the largest and most diverse selection of tire mount/demount irons in the world. From the **T45A-2000K™** for standard truck tires, to the **T45SX** and **T45DX** for wide-base Super Singles, Ken-Tool makes a tire iron for all your tire changing needs. Use on truck, agricultural, and industrial tires. Patented one-piece manufacturing process and design assures long life and superior performance. Heat-treated for strength. Three sizes for many service needs. Use in pairs. **T45A®** is a registered trademark of Ken-Tool. U.S. Patent No's 348,595 and 5,343,921.

Mount



Mount



Demount



Demount



Aluminum Wheel Protector

Protector de cubiertas de aluminio

Protecteur pour roues en aluminium



Protect expensive rims from damage during manual tire changing. Prevents tire tools from marring or scratching aluminum or steel rims when using Ken-Tool's manual tire changing tools. Durable leather protector fits on the rim and protects inside of the rim well. Use with an assortment of tire tools including: T45A® - style tire irons, Serpent™, tire spoons, other Ken-Tool tire changing tools. When one end wears out, flip it over and use the opposite end. Great for roadside service or in the shop. U.S. Patent No. 6,991,018.

Model	EDP No.	Description	Weight
31810	31810	Leather	.35 lbs (.15 kg)

NEW DESIGN

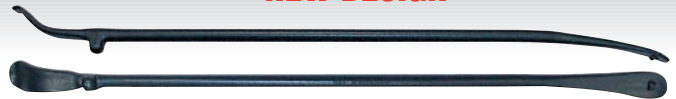

Ken-Tool's patented design offers one piece construction, and assures long life for many tire changing applications.

New rounded tip ends insert easily and will not cut or rip bead or sidewall. The new design makes it easier to mount and demount tires without changing the way the tool is used.



NEW
Rounded Tip

Old



Mount end: Precision forged knob grips rim. New design won't slip during tire mounting. Special curve design always grabs the bead edge.



Demount end: Precision-forged angled tip slides between bead and rim easily. Forged design won't slip when demounting the second bead.

Model	EDP No.	Length	Stock	Weight
T45A®	34645	37" (94 cm)	3/4" (19 mm)	4.6 lbs (2.1 kg)
T45HD	34647	41" (104 cm)	7/8" (22 mm)	7 lbs (3.2 kg)
T47A	34847	52" (132 cm)	1" (25 mm)	11 lbs (5.0 kg)

Standard T45A® Style Tubeless Tire Iron

Barra para llanta sin cámara estilo T45A® estándar

Démonte-pneu standard style T45A® pour pneus sans chambre à air



Design allows for less effort, provides excellent wheel/rim surface contact area for less side to side movement. Improved blade and knob design. Tip on one end for 'grabbing' the rim.

Model	EDP No.	Length	Stock	Weight
T45A-2000K™	34644	37" (94 cm)	3/4" (19 mm)	5 lbs (2.2 kg)

Bead Holding Device

Dispositivo para soporte de llantas

Dispositif de retenue des talons



NEW DESIGN

Now reaches over extra wide bead of super singles.

Holds the bead in place against the wheel when mounting the tire on to the wheel. Do not use to pry.

Model	EDP No.	Description	Weight
31710	31710	Solid Brass	1.8 lbs (.8 kg)

For additional mount / demount tire irons see the Serpent Tire Changing Systems on pages 24 - 27

Cross-Pein / Blacksmith Hammer

Martillo de mano/de peña
Marteau à panne de travers/de forgeron

High carbon steel with machine polished face.



Top Grade U.S. Hickory Handle

Mango U.S. Hickory de primera calidad
Manche de qualité supérieure U.S. Hickory

Model	EDP No.	Length	Face	Eye Size	Head Weight
85H-3	37103	16"	1-5/8"	1 x 1-3/4"	3 lbs (1.4 kg)

Premium Fiberglass Handle

Mango de fibra de vidrio Premium
Manche en fibre de verre supérieur



Model	EDP No.	Length	Face	Eye Size	Head Weight
85G-3	37113	16"	1-5/8"	1 x 1-3/4"	3 lbs (1.4 kg)

New England Pattern Hand-Drilling Hammers

Martillos perforadores de mano con patrones de Nueva Inglaterra

Perforateur manuel modèle 'New England'

Top grade U.S. hickory handle.



Model	EDP No.	Length	Face	Eye Size	Head Weight
80H-3	37003	10-1/2"	1-1/2"	1 x 3/4"	3 lbs (1.4 kg)
80H-4	37004	10-1/2"	1-5/8"	1 x 3/4"	4 lbs (1.8 kg)

Tire Knockers

Golpeadores de llantas
Bâtons de vérification de pression des pneus



Model	EDP No.	Length	Weight
35110	35110	18" (46 cm)	.7 lbs (.3 kg)

Dead Blow Hammers

Martillos de golpe seco • Masse sans rebond

Head is shot filled for maximum force with no bounce effect. Safest non-marring, non-sparking hammers available. Great for tire changing and general shop use. High quality materials to withstand years of hard use.

Economy Strike Pro®

Económico • Économique

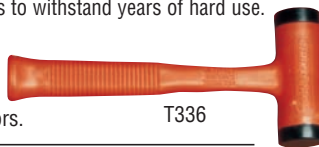

Dead blow action in high visibility colors.

T336

Model	EDP No.	Color	Length	Nominal Weight
T335	35335	Safety Yellow	12" (31 cm)	1 lb (.5 kg)
T336	35336	Safety Orange	12" (31 cm)	1.5 lbs (.7 kg)

Professional Dead Blow

Martillo de golpe seco profesional
Masse professionnelle sans rebond



TG337 Steel face

Power-drive fiberglass handle gives 20% more driving power, yet reduces user fatigue. One-pound dead blow hammer is especially useful for truck wheel weights.

Model	EDP No.	Description	Length	Nominal Weight
TG331	35331	1 lb Head (.5 kg)	12-1/4" (31 cm)	1.8 lbs (.8 kg)
TG332	35332	2 lb Head (.9 kg)	13-1/2" (34 cm)	1.9 lbs (.9 kg)
TG333	35333	3 lb Head (1.4 kg)	14-1/2" (37 cm)	2.7 lbs (1.2 kg)
TG334	35334	4 lb Head (1.8 kg)	15-1/2" (40 cm)	3.4 lbs (1.5 kg)
TG337	35337	Steel Face / Soft Face	13-1/2" (34 cm)	2.2 lbs (1.0 kg)

WARNING: Always wear safety goggles when using striking or struck tools. Never use one hammer to strike another hammer. Never use a tool with a loose or damaged handle. Discard any striking or struck tool if tool shows dents, cracks, chips, or mushrooming.



Duck-Billed Bead Breaking Wedges

Our most popular bead breakers.
Cuñas desmontadoras de llantas de boca plana
Coins d'écartement de talons en bec de canard

T11E®



Wood Handled • Con mango de madera • Manche en bois

Model	EDP No.	Handle No.	Length	Weight
T11D	35327	T11DH	17" (43 cm)	4.8 lbs (2.2 kg)
T11E®	35329	T11EH	30" (76 cm)	11 lbs (5 kg)

Fiberglass Handled

Con mango de fibra de vidrio • Manche en fibre de verre

Model	EDP No.	Handle No.	Length	Weight
TG11D	35427	TG11DH	18" (46 cm)	4.8 lbs (2.2 kg)
TG11E	35429	TG11EH	32" (81 cm)	11 lbs (5 kg)

Polymer Handled

Con mango de polímero
Manche en polymère

Hump Design prevents tool from wedging between rim and bead. Breaks the bead with little or no prying. New polymer handle design for longer lasting everyday use. Full length fiberglass core for greater strength. Coating on handle provides durability.



U.S. Patent no. 6,327,033

Handle cross section

Model	EDP No.	Replacement Handle	Length	Head Weight
T11K™	35460	T11KH (35230)*	32" (81 cm)	10.5 lbs (4.8 kg)

*New handle design T11KH (35230) will not work with old style T11E head

Double-Face Sledge Hammers

Mazas dobles
Masses à double-face

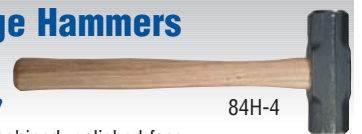

84H-4

High carbon steel, heat treated. Machined, polished face.

Top Grade U.S. Hickory Handle

Mango U.S. Hickory de primera calidad
Manche de qualité supérieure U.S. Hickory

Model	EDP No.	Length	Face	Eye Size	Head Weight
84H-2	37302	15"	1-1/2"	3/4" x 1"	2 lbs (.9 kg)
84H-4	37304	15"	1-3/4"	3/4" x 1"	4 lbs (1.8 kg)
84H-8	37308	32"	2"	1" x 1-3/8"	8 lbs (3.6 kg)
84H-10	37310	36"	2-1/8"	1" x 1-3/8"	10 lbs (4.5 kg)
84H-12	37312	36"	2-1/8"	1" x 1-3/8"	12 lbs (5.4 kg)
84H-16	37316	36"	2-3/8"	1" x 1-3/8"	16 lbs (7.2 kg)
84H-20	37320	36"	3"	2" x 1.5"	20 lbs (9.0 kg)

2 lb. Rubber Mallet

Mazo de goma de 2 libras
Maillet en caoutchouc de 2 lb

Rubber head minimizes marring surfaces.



Model	EDP No.	Handle Length	Head Weight
T32	35310	17"	2 lbs (.9 kg)

General Purpose Tire Hammers • *Martillos para llantas universales • Masse à tout usage*

Designed for tire service in a variety of sizes and styles. Use rubber head replacement **T11RH (35104)**.

Wood Handled

Con mango de madera

Manche en bois

Model	EDP No.	Handle No.	Length	Weight
T11B	35311	T11BH	14-1/2" (37 cm)	4.5 lbs (2.0 kg)



Model	EDP No.	Handle No.	Length	Weight
T11R	35313	T11HN	14" (36 cm)	2.8 lbs (1.2 kg)



Model	EDP No.	Handle No.	Length	Weight
T33R	35317	T11HN	14" (36 cm)	2.3 lbs (1.0 kg)



Fiberglass Handled

Con mango de fibra de vidrio

Manche en fibre de verre

Model	EDP No.	Handle No.	Length	Weight
TG11B	35411	TG11BH	16" (41 cm)	4.8 lbs (2.1 kg)



Model	EDP No.	Handle No.	Length	Weight
TG11R	35413	TG31H	16" (41 cm)	2.9 lbs (1.3 kg)

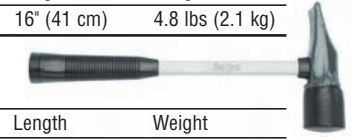

Model	EDP No.	Handle No.	Length	Weight
TG33R	35417	TG31H	16" (41 cm)	2.5 lbs (1.1 kg)

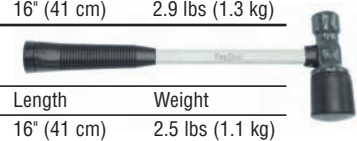

Heavy Duty Tire Hammers • *Martillos para llantas de alta resistencia • Masses à pneu robuste*

Hammers are used for mounting and demounting tires. They make tire changing faster and easier for passenger car, truck, bus, farm tractor, and aircraft tires. A variety of weights and sizes are offered to meet all your tire changing needs. Non-marring rubber end can be used for driving on lock rings.

Use rubber head replacement **T34RH (35105)**.

Wood Handled

Con mango de madera

Manche en bois

Model	EDP No.	Handle No.	Length	Head Weight	Weight
T34	35321	T11CH	17"	4.8 lbs	5.4 lbs
			43 cm	2.2 kg	2.4 kg

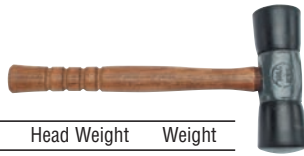

Model	EDP No.	Handle No.	Length	Head Weight	Weight
T35	35323	T11CH	16-1/2"	5.5 lbs	6.1 lbs
			42 cm	2.5 kg	2.7 kg



Model	EDP No.	Handle No.	Length	Head Weight	Weight
T36	35325	T11CH	16-1/2"	5.8 lbs	5.3 lbs
			42 cm	2.6 kg	2.4 kg



Fiberglass Handled

Con mango de fibra de vidrio

Manche en fibre de verre

Model	EDP No.	Handle No.	Length	Head Weight	Weight
TG34	35421	TG11CH	18"	5.5 lbs	6 lbs
			46 cm	2.5 kg	2.7 kg



Model	EDP No.	Handle No.	Length	Head Weight	Weight
TG35	35423	TG11CH	18"	4.8 lbs	6.6 lbs
			46 cm	2.2 kg	3.0 kg



Model	EDP No.	Handle No.	Length	Head Weight	Weight
TG36	35425	TG11CH	18"	5.8 lbs	6 lbs
			46 cm	2.6 kg	2.7 kg



Replacement Handles • *Mangos de repuesto • Manches de remplacement*

Top Quality U.S. Hickory

U.S. Hickory de máxima calidad

Qualité supérieur U.S Hickory



Model	EDP No.	For Hammer No.	Length	Weight
T11BH	35111	T11B	15" (38 cm)	.75 lbs (.3 kg)
T11HN	35113	T11R, T31, T33R	15" (38 cm)	.75 lbs (.2 kg)
T11CH	35119	T11C, T34, T35, T36	17" (43 cm)	.75 lbs (.3 kg)
T11DH	35127	T11D	17" (43 cm)	.75 lbs (.3 kg)
T11EH	35129	T11E®	30" (76 cm)	1.2 lbs (.5 kg)

Aluminum • *Aluminio • Aluminium*



Model	EDP No.	For Hammer No.	Length	Weight
T11AH	35529	T11E®, TG11E	32" (81 cm)	4.3 lbs (2 kg)

Polymer • *Polímero • Polymère* Patented



Model	EDP No.	For Hammer No.	Length	Weight
T11KH	35230	T11K™	32" (81 cm)	2.3 lbs (1.0 kg)

Fiberglass • *Fibra de vidrio • Fibre de verre* TG37H



Model	EDP No.	For Hammer No.	Length	Weight
TG31H	35206	TG11R, TG31, TG33R	16" (41 cm)	1 lb (.5 kg)
TG11BH	35211	TG11B	16" (41 cm)	1.3 lbs (.6 kg)
TG11CH	35219	TG11C, TG34, TG35, TG36	18" (46 cm)	2.5 lbs (1.1 kg)
TG11DH	35227*	TG11D	18" (46 cm)	1.2 lbs (.5 kg)
TG11EH	35229*	TG11E	32" (81 cm)	2.3 lbs (1.0 kg)

* Nulok adapter (others use epoxy).

Replacement Rubber Heads

Cabezas de goma de repuesto

Tête de remplacement en caoutchouc



Model	EDP No.	Description	For Hammer No.
T11RH	35104	Rubber Head	T11R, TG11R, T33R, TG31
T34RH	35105	Rubber Head	T34, TG34, T35, TG35, T36, TG36

Epoxy Kits • *Equipos de epoxi • Ensembles en époxy*

Model	EDP No.	Description	For Hammer No.
T12B	35201	Epoxy Kit	TG11B, TG11R, TG31, TG33R
T12D	35202	Epoxy Kit	TG34, TG35, TG36, TG37

Tire Inflation Cages • Cajas para inflado de llantas • Cages de sécurité pour gonflement de pneus

Mandatory for any shop working with tubeless and multi-piece rims. Made from heavy-gauge steel tubing welded to a steel base. Guards against blown lock rings and rims. Follow OSHA regulation 29-CFR Part 1910.177. Read safety label on cage. Designed to meet OSHA regulation requirements for Medium, Heavy-Duty Truck, OTR, Tractor, and Super Singles. Ken-Tool offers sizes and designs for all your needs. For additional safety labels, instructions or OSHA rim matching charts, call Ken-Tool customer service.

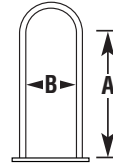

Work safely.
Always use an inflation cage when inflating tires.
Follow OSHA regulation 29-CFR Part 1910.177 whenever changing tires.

Passenger and Light Truck Cage

Jaula para camión liviano y para pasajeros

Cabine passager et véhicule utilitaire léger

A must for run-flat, low-profile, and other tires that are difficult to seat.



Model	EDP No.	Height A**	Width B	Base	Weight
T103	36003	30" 76 cm	16" 41 cm	21-1/2" x 22" 55 cm x 56 cm	80 lbs 36.2 kg

NEW

Portable Wide Base Cage

Caja con base amplia portátil
Cage portative à base large

Especially designed for wide base tires, this portable inflation cage will hold super singles, and super wide radial tires. Fits comparable tires up to: 445/50R 22.5.



Model	EDP No.	Height A**	Width B	Base	Weight
T101A	36007	43-1/2" 111 cm	20-1/2" 52 cm	7" closed x 27" 18 cm closed x 69 cm	72 lbs 32.6 kg

Portable 2-Bar Cage

Caja de dos barras portátil • Cage portative à deux barres

U.S. Patented No. D270,216

Model	EDP No.	Height A**	Width B	Base	Weight
T101	36001	41" 104 cm	16" 41 cm	7" closed x 21-1/2" 18 cm closed x 55 cm	60 lbs 27.2 kg

3-Bar Cage

Caja de 3 barras

Cage à 3 barres



Model	EDP No.	Height A**	Width B	Base	Weight
T106	36006	43-1/2" 111 cm	20-1/2" 52 cm	26" x 22" 66 cm x 56 cm	134 lbs 60.7 kg

4-Bar Cage

Caja de 4 barras

Cage à 4 barres



Model	EDP No.	Height A**	Width B	Base	Weight
T102	36002	43-1/2" 111 cm	20-1/2" 52 cm	31-1/2" x 26" 80 cm x 66 cm	146 lbs 66.2 kg

5-Bar Cage

Caja de 5 barras

Cage à 5 barres



Model	EDP No.	Height A**	Width B	Base	Weight
T105	36005	43-1/2" 111 cm	20-1/2" 52 cm	41" x 26" 104 cm x 66 cm	182 lbs 82.5 kg

3-Bar Cage (OTR)

Caja de 3 barras (de carretera)

Cage à 3 barres (pneus tout terrain)



Model	EDP No.	Height A**	Width B	Base	Weight
T104	36004	65" 165 cm	24" 61 cm	30" x 27" 76 cm x 69 cm	158 lbs 72.6 kg

** Height A refers to the approximate height to the inside bend of the cage.

WARNING: Tire changing can be dangerous, and should be done only by trained personnel using proper tools and equipment as directed by Federal OSHA Standard No. 29 CFR Part 1910.177. Tires may explode during inflation causing injury to operator or bystander. Wear safety goggles. Keep all parts of body outside cage. Use extension hose, clip-on chuck, and remote valve. See supervisor for safety procedures.

WARNING: Do not alter cage in any way. Cage must be freestanding and at least three feet from other objects. Discard cage if bent, cracked, or otherwise damaged. Always wear safety goggles.

Truck Tire Changing Stand

Soporte para cambio de llantas de camiones

Support de démontage pour pneus de camions



Stand handles wheels or open rims 16.5" to 24". Double-slide adjustment with locking device prevents twisting so it stays aligned with the wheel or rim. Stand is the ideal height for driving off beads or demounting tires. It must be used to be appreciated.

Model	EDP No.	Weight
T115	36015	21 lbs (9.5 kg)

Tire Snake®

'Snake® para llantas / 'Snake® Outil à pneu Snake®



Tire Snake mounting and demounting tools for use with center post tire changers. Included with T600 Tire Changer, designed for wheels from 4" to 12". Included with T601 Tire Changer, designed for wheels from 4" to 15", the longer length provides greater leverage. U.S. Patent nos. 5,971,052 and D412,271.

Model	EDP No.	Length	Stock	Weight
TS72	34672	22" (56 cm)	5/8" (2 cm)	2 lbs (.9 kg)
TS74	34674	28" (71 cm)	5/8" (2 cm)	2.5 lbs (1.1 kg)
NEW TS42	34678	42" (102 cm)	3/4" (19 mm)	5.3 lbs (2.4 kg)

Air Blast Bead Seater for Small Tires

Calzador a chorro de aire para llantas pequeñas

Air comprimé pour repos de talon de petits pneus



For your small tire changing needs, Ken-Tool introduces a fast, easy and economical way to seat beads in one simple operation with the new Air Blast Bead Seater. This patent-pending air-blaster bead seater, seats the bead on most small tubeless tires with rims ranging from 4 to 12 inches. This is a one-man operation; just point, release, and watch this fast-acting bead seater do all the work.

Model	EDP No.	Weight
31440	31440	5.6 lbs (2.5 kg)

ATV Bead Breaker

Desmontadora de llantas para vehículos todo terreno

Décolleur de talon pour VTT



The ATV Bead Breaker is a manual solution that satisfies both manufacturers and tire changing technicians searching for a quick, safe, and affordable ATV bead breaker that really works. A rugged, yet lightweight tool that delivers the tremendous force necessary to overcome the resistance of a bead keeper. Constructed of heavy-duty steel, the ATV Bead Breaker works with any center post tire changing machine and adjusts to sizes of 6 to 12 inch ATV rims without the hassle of clevis pins. No hammers, wrenches, or additional tools are required. Very affordable! U.S. Patent no. 6,273,171.

Model	EDP No.	Weight
38620	38620	7 lbs (3.2 kg)

Manual Tire Changers

Cambiadores de llantas manuales

Démonteurs de pneus manuels

Floor Mount

Montaje de piso

Montage au sol



Threadscrew has been milled to fit MTD wheels.

Mounts and demounts a full range of tires on rim diameters from 4 to 15 inches. Tapered bearing guide positively centers straight shaft hubs of all diameters. A built-in, infinitely adjustable bead breaker works on rims up to 15" in diameter and 24" in width without disassembly. Includes a Ken-Tool exclusive, 28" Tire Snake® mount/demount tire tool. U.S. Patent no. 6,145,566.

Model	EDP No.	Height	Weight
T601	38601	32" (81 cm)	31 lbs (14 kg)

Bench / Rim Clamp Mount

Montaje de banco/ abrazadera de llantas

Montage sur banc/crapaud



Threadscrew has been milled to fit MTD wheels.

Mounts and demounts a full range of tires on rim diameters from 4 to 12 inches. Mounts easily to a bench or in any standard, four-position rim-clamp tire changer. A built-in, three fin centering device mounts standard lug-type rims with 2" and larger center hole. Square base prevents turning in the changer during use. Includes a Ken-Tool exclusive, 22" Tire Snake® mount/demount tire tool. U.S. Patent no. 6,145,566.

Model	EDP No.	Height	Weight
T600	38600	16-1/2" (42 cm)	21.7 lbs (10 kg)

For additional small tire tools see page 35

Professional Lug Nut Cover Remover

Desmontador profesional de cubierta con tuercas
Dégageur professionnel d'écrous d'enjoliveurs de roues

Special coating will not scratch or damage chrome, painted, or coated lug nut covers.



Model	EDP No.	Weight
30606	30606	1.3 lbs (.6 kg)

Tire Bead Seaters

Calzador para llantas • Cordons de talon de pneus

One-piece rubber tube for mounting hard-to-seat radial, bias-belted, or conventional truck tires. As tire is inflated, the lubricated bead seater forms a seal between the rim and tire, allowing the air pressure to force the beads into the rim flange. As proper pressure is reached, the bead seater slides out and over the rim. Use bead lubricant with bead seaters.



Passenger / Light Truck

Camión liviano/vehículo de pasajeros • Automobile/camion léger

Model	Fits Rim Sizes	Weight
31446	14-15" (36 - 38 cm)	1.5 lbs (.7 kg)

Truck • Camión • Camion

Model	Fits Rim Sizes	Weight
31437	16-1/2" to 17-1/2" (42 to 45 cm)	2 lbs (.9 kg)
31438	19-1/2" (50 cm)	2.3 lbs (1.0 kg)
31439	22-1/2" to 24-1/2" (57 to 62 cm)	2.3 lbs (1.0 kg)

Pneumatic Bead Expanders

Expansores neumáticos de llantas
Tubes d'extension de talon pneumatiques

Expanders fit most bias ply passenger tires. A pliable neoprene rubber tube is encased in a tough, long-lasting nylon cover. Expanders slip easily over tire and withstand contact with oil, grease, solvents, and acids. Follow instructions included with tool. Use on bias ply, 14", 15", 70-series tires and larger. Expands bead by compressing tread. **T132** for belted bias ply tires, includes over-pressure release valve. **T133** for standard bias ply tires.

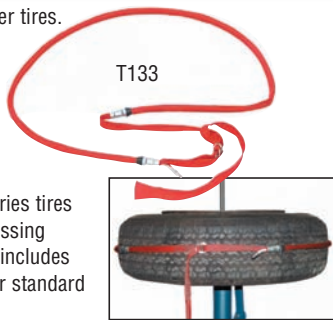

Model	EDP No.	Min / Max Diameter	Tube Diameter	Weight
T132	31432	24 - 34" (61 - 86 cm)	2-1/4" (6 cm)	2.8 lbs (1.2 kg)
T133	31433	22 - 32" (60 - 81 cm)	3/4" (2 cm)	.75 lbs (.3 kg)

Wheel Cover & Wheel-Lock Removal Kit

Equipo para extracción de cubiertas y anillos de retención de ruedas

Trousse de démontage des enjoliveur et bloqueur de roue

Remove and replace GM, Ford, Chrysler hubcap locks and aftermarket wheel lug locks without the factory issued key. Save time! Will not damage the lock or stud.



Model	EDP No.	Weight
30170	30170	2.5 lbs (1.1 kg)

Deep, Thin Wall Flip Socket

Llave de tubo movable, de paredes finas y profundidad

Douille double tête profonde à paroi étroite



1/2" square drive, black impact socket is deep and thin walled to reach areas conventional sockets won't. Flip socket provides two socket sizes which cover virtually all SAE automotive wheel lug sizes.

Model	EDP No.	Socket Sizes	Drive	Weight
30156	30156	3/4", 13/16"	1/2" square	.4 lbs (.18 kg)
30158	30158	19 mm, 21 mm	1/2" square	.4 lbs (.18 kg)

Universal Emergency Wheel-Lock Remover

Desmontador universal para anillos de seguridad de ruedas de emergencia

Dégageur de bloqueur de roue universel de secours

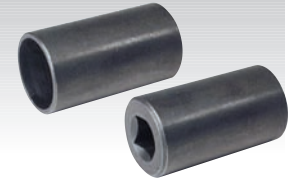

Removes wheel locks when the key is lost or misplaced. Tapered socket fits over most car wheel locks. Use soft-faced hammer to drive onto wheel lock. Limited use.

Model	EDP No.	Drive	Weight
30161	30161	1/2"	1 lb (.5 kg)

Heavy-Duty Impact Sockets

Llaves de tubo de impacto de alta resistencia
Douilles résistantes aux chocs

Special Purpose Impact Sockets Off-Road Budd, Square, SAE, and Metric

Llaves de tubo de impacto especializados para todo terreno tipo Budd, cuadrados, de SAE y métricos

Douilles carrées, SAE, métrique ou pour roues à disques, spécialement conçues pour résister aux chocs



Special 1-1/2" hex deep heavy-duty impact socket designed for outer cap nuts on Budd-style truck wheels. The 1-1/2" hex depth is limited to help prevent socket contact with the wheel. The socket is deep style to eliminate contact with the inner cap nut.

3/4" Drive		1" Drive		Weight
Model	Description	Model	Description	
30120	13/16" square	30149	13/16" square	1.4 lbs (.6 kg)
30352	21 mm square	30362	21 mm square	1.1 lbs (.5 kg)

Combination Budd Wheel - SAE and Metric

Rueda de combinación tipo Budd- SAE y métrica
Deux en un pour roues à disques - SAE et métrique

3/4" Drive		1" Drive		Weight
Model	Description	Model	Description	
30121	1-1/2" x 13/16" square	30150	1-1/2" x 13/16" square	3.1 lbs (1.4 kg)

Deep Length Impact Sockets - SAE and Metric

Llaves de tubo de impacto de longitud profunda- SAE y métrica
Douilles de profonde longueur - SAE et métrique

6 point, 3/4" Drive		6 point, 1" Drive		Weight
Model	Description	Model	Description	
30356	33 mm deep	30366	33 mm deep	1.6 lbs (.7 kg)

Socket Sets

Juegos de llaves de tubo • Jeux de douilles

Three Piece Thinwall Flip Socket Set

Juego de llaves de tubo movibles, de paredes finas de tres piezas

Jeu de trois douilles double tête à paroi étroite

One end is a standard 6-point socket for everyday use. Flip socket over and you have a 6-point socket of larger size.

Socket sizes:

- 19mm - 21mm socket
- 3/4" - 13/16" socket
- 3" extension, 1/2" drive



Model	EDP No.	Drive	Weight
30110	30110	1/2"	1.2 lbs (.54 kg)

Six Piece Double-Duty Flip Socket Set

Juego de llaves de tubo movibles de dos funciones y seis piezas

Jeu de six douilles double tête à deux usages

One end is a standard 6-point socket for everyday use. Flip socket over and you have a 6-fluted twist socket for removing damaged or rounded wheel lugs.

Socket sizes:

- 17mm socket 7/8" socket
- 13/16" socket 21mm socket
- 19mm, 3/4" socket 3" extension



Model	EDP No.	Drive	Weight
30111	30111	1/2"	2.8 lbs (1.2 kg)

Six Piece Thick and Thin Flip Socket Set

Juego de llaves de tubo movibles, finas y gruesas de seis piezas

Jeu de six douilles à extrémités épaisses et minces

For those ever changing aftermarket and manufacturers' wheels. One end is a standard 6-point socket for everyday use. Flip socket over and you have a thinwall socket of the same size for wheels with minimal clearance.

Socket sizes:

- 17mm socket 7/8" socket
- 13/16" socket 21mm socket
- 19mm, 3/4" socket 3" extension



Model	EDP No.	Drive	Weight
30112	30112	1/2"	3 lbs (1.3 kg)

Six Piece Deep Thinwall Impact Socket Set

Juego de llaves de tubo de impacto, de paredes finas y profundidad de seis piezas

Jeu de six douilles profondes à paroi étroite résistante aux chocs

For the difficult aftermarket and manufacturers' wheels.

Socket sizes:

- 17mm socket 7/8" socket
- 13/16" socket 21mm socket
- 19mm, 3/4" socket 3" extension



Model	EDP No.	Drive	Weight
30113	30113	1/2"	3 lbs (1.3 kg)

Five Piece Double-Duty Oil Drain Plug Removal Flip Socket Set

Juego de llaves de tubo movibles para extracción del tapón de drenaje de aceite de doble función y cinco piezas

Jeu de cinq douilles à usages régulier et dégagement de bouchon de vidange d'huile

One end is a standard 6-point socket for everyday use. Flip socket over and you have a twist socket damaged oil drain plug remover of the same size.

Socket sizes:

- 14mm socket 19mm, 3/4" socket
- 17mm socket 16mm, 5/8" socket
- 15mm socket



Model	EDP No.	Drive	Weight
30114	30114	3/8"	3 lbs (1.3 kg)

Three Piece Lug and Lock Flip Socket Set

Juego de llaves de tubo movibles para ruedas y anillos de seguridad de tres piezas

Jeu de cinq douilles à extrémités écrous et bloqueurs

One end is a standard 6-fluted twist socket for removing damaged wheel lugs. Flip socket over and you have a 12-fluted twist socket for removing wheel locks.

Socket sizes:

- 19mm, 3/4" socket
- 7/8" socket
- 3" extension



Model	EDP No.	Drive	Weight
30115	30115	1/2"	1.6 lbs (.7 kg)

Five Piece Deep Twist Socket Set

Juego de llaves de tubo articuladas y de profundidad, de cinco piezas

Jeu de cinq douilles profondes de dévissage

Easily removes rounded, damaged, or corroded nuts, bolts, pipe nipples and studs. Convenient storage/organizer bar.

Socket sizes:

- 19mm, 3/4" socket 1" socket
- 15/16" socket 7/8" socket
- 13/16" socket



Model	EDP No.	Drive	Weight
30116	30116	1/2"	2.5 lbs (1.1 kg)

No-Mar Rim Guard™

Tapa para llantas No-Mar

Protection de jante antimarque

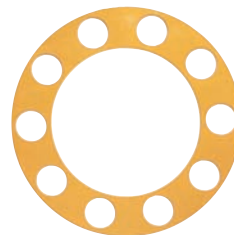

Protective cover prevents damage to chrome and aluminum rims and wheels when removing or replacing lug nuts. Imprinted with torque sequence number for proper torquing of disc wheels.

Model	EDP No.	Description	Weight
30605	30605	Protective plastic cover	.5 lbs (.2 kg)

Tire Spreaders

Separadores de llantas • Écarte-pneus

Tire Spreader with Lock Pin

Separador de llanta con pasador de bloqueo

Écarte-pneu avec goupille de sécurité



Model	EDP No.	Spread Capacity	Weight
T51	31551	4" - 6" (10-15 cm)	3.9 lbs (1.7 kg)

Tire Spreader

Separador de llanta

Écarte-pneu



Model	EDP No.	Spread Capacity	Weight
T53	31553	7-1/2" (19 cm)	3 lbs (1.4 kg)

Ratchet Action Truck Tire Spreader

Separador de llantas para camiones

Ratchet Action

Écarte-pneu à rochet pour camions



Model	EDP No.	Spread Capacity	Weight
T54	31554	3-1/2" - 14" (9 - 36 cm)	7.3 lbs (3.3 kg)

Wire Brush

Cepillo de alambre • Brosse métallique



Cleans rust from rims

Model	EDP No.	Length	Weight
T15	30515	14" (36 cm)	5 oz. (.2 kg)

"Challenger" Wheel Balancer

Balanceador de ruedas • Équilibreuse de roues

Accurate, easy-to-operate, self-leveling balancer with easy-to-read circular level accurately balances all wheels when using regular weights. Bubble type balancer is portable and may be used indoors or outdoors, even on a stone driveway. Convenient built-in weight storage space in the base of the balancer combines everything needed in 2 sq. ft. of floor space. All steel parts are plated to resist rust. Most passenger car wheels can be balanced directly on the balancer. Bubble will not freeze. Restriction: Minimum 1-1/2" diameter hub holes to maximum 4-1/2" hub holes.



Model	EDP No.	Description	Size	Weight
B260	31360	Wheel Balancer	22"H x 12"W x 12"L	14 lbs (6.4 kg)
B261	31360-01	Balance Head		5.3 lbs (2.4 kg)
B262	31360-99	Bubble Device		.75 lbs (.3 kg)

Wheel Tools

Herramientas para ruedas • Outils pour roues

Wheel Weight Pliers

Alicates para pesar ruedas • Pinces de masse d'équilibrage



These rugged pliers are designed to grip wheel weights firmly, with or without a hole in the clip, and to remove them quickly and easily. Balanced hammer head drives clips into place with a few light blows. The end of the handle is offset and flat to remove wheel covers. Finished in a bright luster plate.

Model No.	EDP No.	Jaw Style	Length	Weight
7220	7220	Straight	10" (25.4 cm)	.97 lbs (.44 kg)
7221	7221	Angle	10" (25.4 cm)	1 lb (.5 kg)

Heavy-Duty Wheel Weight Pliers

Alicates para pesar ruedas de alta resistencia

Pinces de masse d'équilibrage robustes



These rugged truck-style wheel weight pliers are designed for heavy-duty use. They will grip wheel weights firmly, with or without a hole in the clip, and remove them quickly and easily. The extra large, perfectly balanced hammer head drives clips into place with a few light blows. The angle jaw style allows you to install weights on the back side of the wheel, as well as the front side. Finished in a bright luster plate.

Model No.	EDP No.	Jaw Style	Length	Weight
7218	7218	Straight	10" (25.4 cm)	1.5 lbs (.68 kg)
7219	7219	Angle	10" (25.4 cm)	1.5 lbs (.68 kg)

Grease Cap Remover

Desmontador de engrasador

Dégazeur de chapeau



Makes a messy, time consuming job easy. The thin jaws of these powerful pliers slip behind the grease cap, and the wedge shape of the jaws forces the cap away from the hub. The end of the handle has been machined for the quick removal of wheel covers. The finish is bright luster plate.

Model No.	EDP No.	Length	Weight
7223	7223	11-1/2" (29.2 cm)	1.1 lbs (.5 kg)

Professional Wheel Weight Tool

Herramientas profesional para pesar ruedas

Outil professionnel pour masses d'équilibrage

Clip-claw crowbar, punch designed handles, and heavy hammerhead provide years of use.



Model	EDP No.	Weight
B230	35354	1 lb (.5 kg)

Standard Wheel Weight Tool

Herramientas estándar para pesar ruedas

Outil standard pour masses d'équilibrage

This passenger car wheel weight tool is the industry standard.



Model	EDP No.	Weight
B232	35355	1 lb (.5 kg)

MacPherson Strut Coil Spring Compressor Set

*Equipo compresor de resorte
espiral de montante MacPherson
Groupe compresseur de ressort
hélicoïdal à jambe de suspension*

Compressor works on most MacPherson Strut assemblies and is for use with replacements. Use the compressor when replacing bent strut or strut tube and damaged spindles. Use it on or off the car. Acme threaded screw for durability. Do not use on General Motors "A", "C", "J", or "X" body cars.

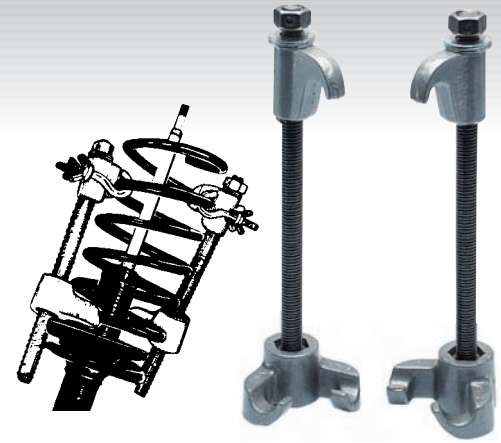

Model	EDP No.	Weight
39730	39730	7 lbs (3.1 kg)

Front End Service Tools

*Herramientas para el mantenimiento delantero
Outils de service du train avant*

These tools are manufactured from a single piece of alloy steel, forged, and heat-treated for long life. Essential when replacing suspension parts. Striking ends have been enlarged to provide a bigger and safer striking surface. Painted finish for rust resistance. Ken-Tool offers a size and design for all your needs.

Separator Tool • Herramienta separadora • Séparateur



Use to remove camber adjustment sleeves on Ford 4 x 2 and 4 x 4 pickups. Use as Pitman arm wedge on medium and heavy-duty trucks.

Model	EDP No.	Length	Stock	Fork Opening	Weight
B36	32036	11" (28 cm)	7/8" (2 cm)	1-7/16" (4 cm)	1.9 lbs (.8 kg)

Pitman Arm Wedge

*Cuña para la biela de mando de la dirección
Coin pour bielle pendante*



Removes Pitman arms on cars and light trucks.

Model	EDP No.	Length	Stock	Fork Opening	Weight
B37	32037	11" (28 cm)	7/8" (2 cm)	1- 1/8" (3 cm)	1.8 lbs (.8 kg)

Shock Link and Tie Rod Separator

*Separador de la barra de acoplamiento y la unión del amortiguador
Fourche à barre d'accouplement et articulation d'amortisseur*



Use to separate shock absorber links and tie rods.

Model	EDP No.	Length	Stock	Fork Opening	Weight
B39	32039	16" (41 cm)	7/8" (2 cm)	5/8" (2 cm)	2.1 lbs (.9 kg)

Ball Joint Separator

Separador de juntas de rótulas • Séparateur de joint à rotule



Use on spindle support arms to remove ball joints without damaging other suspension parts. Services compact cars and light duty trucks.

Model	EDP No.	Length	Stock	Fork Opening	Weight
B40	32040	16" (41 cm)	7/8" (2 cm)	15/16" (2 cm)	2.8 lbs (1.2 kg)

BeadEze® Tire Lubricant

*'BeadEze®' Lubricante para llantas
'BeadEze®' Lubrifiant à pneus*



Lubricates tire and rim for ease in mounting. Dries quickly. Makes excellent leak detector when diluted.

Model	EDP No.	Description	Weight
T147A	35847	One Gallon	9 lbs (4.1 kg)

Detecto Mist® Air Leak Locator

*'Detecto Mist®' Detector de fugas de aire
'Detecto Mist®' Indicateur de fuite d'air*



Concentrated formula dilutes with water. Spray on tire or casing to instantly detect leaks. Ends messy dunking.

Model	EDP No.	Description	Weight
D105A	35805	One Quart	2.3 lbs (1 kg)

Bead Lubricant Swab

*Paño lubricante para llantas
Tampon pour lubrificateur de talon*



Use with T147A tire lubricant.

Model	EDP No.	Length	Weight
B111	30511	10" (25.4 cm)	3 oz (.1 kg)

Professional 4-Way Valve Core Tool

*Herramienta profesional para
núcleos de válvulas de 4 vías
Outil à valve professionnel
4 en 1 pour noyaux*



Handy 4-in-1 standard valve tool repairs cap threads, repairs core threads, has special easy-out feature for removing damaged cores, and screwdriver for removing standard cores. Black, heavy-duty hardened steel.

Model	EDP No.	Weight
T16P	30215	1 oz (.04 kg)



Economy Four-Way Lug Wrenches for the Do-It-Yourselfer

Llaves cruz económicas para aficionados

Clés à goujon à quatre têtes économiques pour le bricoleur

With NutBusters you have a complete line of lug wrenches value priced and merchandised to maximize your DIY business... And they're all tough and dependable - just what you'd expect from something called NutBuster!



Passenger Car

Vehículo de pasajeros

Automobile

Chrome-plated finish, welded center. Imported

Model	EDP No.	Socket Sizes	Length	Stock	Weight
35630	35630	17 mm, 19 mm (3/4"),	20"	5/8"	3.7 lbs
		21 mm (13/16"), 23 mm (7/8")	51 cm	16 mm	1.7 kg
35635	35635	17 mm, 19 mm (3/4"),	14"	5/8"	2.6 lbs
		21 mm (13/16"), 23 mm (7/8")	36 cm	16 mm	1.2 kg

Folding Passenger Car

Vehículo de pasajeros con asientos plegables

Voiture automobile, pliable

Chrome-plated finish. Imported



Model	EDP No.	Socket Sizes	Length	Stock	Weight
35633	35633	17 mm, 19 mm (3/4"),	14"	9/16"	2.7 lbs
		21 mm (13/16"), 23 mm (7/8")	36 cm	14 mm	1.2 kg

Telescoping Passenger Car

Automóvil de pasajeros con asientos extensibles

Voiture automobile, télescopique

Chrome-plated finish. Imported



Model	EDP No.	Socket Sizes	Length	Stock	Weight
35634	35634	17 mm, 19 mm (3/4"),	21"(Extended)		3 lbs
		21 mm (13/16"), 23 mm (7/8")	53 cm		1.4 kg

Passenger Car

Vehículo de pasajeros

Automobile

Painted finish, welded center.

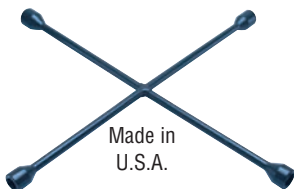

Model	EDP No.	Socket Sizes	Length	Stock	Weight
35637	35637	17 mm, 19 mm (3/4"),	18"	9/16"	3.6 lbs
		21 mm (13/16"), 22 mm (7/8")	46 cm	14 mm	1.6 kg

Light Truck/RV

Camión liviano/ vehículo de recreación

Camionnette/VR

Painted finish, welded center.



Model	EDP No.	Socket Sizes	Length	Stock	Weight
35638	35638	22 mm (7/8"), 24 mm (15/16"),	23"	11/16"	5.6 lbs
		25 mm (1"), 27 mm (1-1/16")	58 cm	17.5 mm	2.5 kg

CROSS REFERENCE CHARTS

HUB-SHARK®

MODEL NO. - PG. NO.

MODEL NO.	PG NO.
7325	3
7373	3

OLDFORGE®

MODEL NO. - PG. NO.

MODEL NO.	PG NO.	MODEL NO.	PG NO.	MODEL NO.	PG NO.	MODEL NO.	PG NO.
1000	10	1974	5	6924	12	7242	9
1001	10	1975	5	6925	12	7243	9
1002	10	H-1975	7	6926	12	7244	9
1003	10	1976	5	6961	12	7245	9
1004	10	1977	6	6962	12	7246	9
1006	10	1978	6	6963	12	7248	9
1008	10	1979	6	6964	12	7250	13
1009	10	1980	6	6965	12	7251	13
1010	10	1981	6	6966	12	7252	13
1013	10	H-1981	7	6967	12	7253	13
1028	11	1982	6	6968	12	7314	12
1030	11	1983	7	6969	12	7318	8
1031	11	1984	7	7002	14	7319	8
1032	11	1985	7	7003	14	7320	8
1034	11	1986	5	7019	14	7321	8
1035	11	1987	6	7025	13	7322	8
1039	10	1988	7	7026	13	7323	6
1042	11	1990	6	7027	13	7330	13
1044	11	1991	6	7028	13	7331	12
1045	11	1993	6	7030	13	7332	12
1046	11	1995	6	7031	13	7341	12
1047	11	1996	6	7032	13	7343	12
1945	14	1997	7	7035	13	7355	13
1948	14	H-1997	7	7037	13	7360	13
1949	14	1998	7	7039	9	7365	9
1955	4	2006	6	7040	9	7394	8
1956	4	2010	5	7045	14	7434	9
1957	4	2011	6	7046	14	7504	9
1958	4	2012	5	7048	14	7505	9
1959	4	2053	7	7055	14	7524	10
1960	4	2526	13	7090	14	7547	11
1961	4	3910	12	7092	14	34118	13
1965	4	3911	12	7093	14	34124	13
1966	4	3912	12	7095	14	34130	13
1967	4	3913	12	7231	13	34212	13
1968	4	3914	12	7233	13	34216	13
1969	4	3915	12	7235	13	34218	13
1970	5	5218P	12	7236	13		
1971	5	5724	12	7237	13		
1972	5	6019	12	7238	13		
H-1972	7	6921	12	7239	13		
1973	5	6923	12	7241	9		

HARD CAP®

MODEL NO. - PG. NO.

MODEL NO.	PG NO.	MODEL NO.	PG NO.	MODEL NO.	PG NO.
65104	20	66412	20	66427	20
65106	20	66414	20	66435	20
65107	20	66422	20	66440	20
65108	20	66423	20	66441	20
66401	20	66424	20	66442	20
				66900	21
				66901	21
				66902	21
				66907	21

VISES & C-CLAMPS

EDP NO. - MODEL NO. MODEL NO. - EDP NO.

EDP NO.	MODEL NO.	PG NO.	EDP NO.	MODEL NO.	PG NO.
39604	KT-4	23	K65	64055	22, 23
39606	KT-6	23	K65	64065	22, 23
39608	KT-8	23	KT-4	39604	23
64055	K65	22, 23	KT-6	39606	23
64065	K65	22, 23	KT-8	39608	23
64650	KT4650	22, 23	KT4650	64650	22, 23
64800	KT4800	22, 23	KT4800	64800	22, 23

SERPENT™

EDP NO. - MODEL NO. MODEL NO. - EDP NO.

EDP NO.	MODEL NO.	PG NO.	EDP NO.	MODEL NO.	PG NO.
35446		27	T2001	35449	24, 25
35447	T2005	26, 27	T2002	35450	24, 25
35448	T2006	27	T2005	35447	26, 27
35449	T2001	24, 25	T2006	35448	27
35450	T2002	24, 25			
35453		25			

CARICA™

EDP NO. - MODEL NO.

EDP NO.	MODEL NO.	PG NO.
17005	TK01BULB	19
17020	TKFIER	18, 19
17025	TKFLEX	19
17030	TKSSANT	18, 19
17035	TKTORCH	19
17055	ABGPV1	15
17065	ABGTEL1	15
17125	151AU-50	16
17150	SSMR01	17
17200	STETH01	16
17205		16
17255		15
17300	TK02MIR	18, 19
17305	TF01	17, 18
17315	TK01MAG	18, 19
17320	TK01MIR	19
17325	TK03MAG	18, 19
17330	TK03MIR	19
17600	FF01	19
17605	FM01	19
17610	FM02	19
17615	FMR01	19
17620	FMR02	19
17625	FMR03	19
17630	GMR01	17
17650	HPMSET1	16
17680	TK1000	18
17690	TK20/20SE	19
17691	TK20/20CASE	19
17700	TK2000	18
17705	TK3000	18
17710	TK4000	18
17715	TK5000	19
17720	TK6000	18
17730	TK8000	19
17750	MR01	17
17755	MR02	17, 18
17760	MR03	17
17765	MR04	17
17770	MGMR01	17
17780	PL01	18
17800	PM01	18
17805	PM01B-M	18
17810	PMG01	18
17830	PMG02	18
17845	PMG03	18
17860	PMG05	18
17910		18
17930		18

CARICA™

MODEL NO. - EDP NO.

MODEL NO.	EDP NO.	PG NO.
ABGPV1	17055	15
ABGTEL1	17065	15
FF01	17600	19
FM01	17605	19
FM02	17610	19
FMR01	17615	19
FMR02	17620	19
FMR03	17625	19
GMR01	17630	17
HPMSET1	17650	16
MGMR01	17770	17
MR01	17750	17
MR02	17755	17, 18
MR03	17760	17
MR04	17765	17
PL01	17780	18
PM01	17800	18
PM01B-M	17805	18
PMG01	17810	18
PMG02	17830	18
PMG03	17845	18
PMG05	17860	18
SSMR01	17150	17
STETH01	17200	16
TF01	17305	17, 18
TK01BULB	17005	19
TK01MAG	17315	18, 19
TK01MIR	17320	19
TK03MAG	17325	18, 19
TK02MIR	17300	19
TK03MIR	17330	19
TK20/20CASE	17691	19
TK20/20SE	17690	19
TK1000	17680	18
TK2000	17700	18
TK3000	17705	18
TK4000	17710	18
TK5000	17715	19
TK6000	17720	18
TK8000	17730	19
TKFLEX	17025	19
TKFIER	17020	18, 19
TKSSANT	17030	18, 19
TKTORCH	17035	19
151AU-50	17125	16

KEN-TOOL®
EDP NO. - MODEL NO.

EDP NO.	MODEL NO.	PG. NO.	EDP NO.	MODEL NO.	PG. NO.	EDP NO.	MODEL NO.	PG. NO.	EDP NO.	MODEL NO.	PG. NO.	EDP NO.	MODEL NO.	PG. NO.	EDP NO.	MODEL NO.	PG. NO.
7218		44	30215	T16P	45	31810		25, 27, 37	34121	T21F	36	35310	T32	38	35659	T59	28
7219		44	30230		33	32036	B36	45	34122	T21HD	36	35311	T11B	39	35661	T61	28
7220		44	30231		33	32037	B37	45	34401	TR10	29	35313	T11R	39	35662	T62	28
7221		44	30232		33	32039	B39	45	34402	TR11	29	35317	T33R	39	35663	T63	28
7223		44	30233		33	32040	B40	45	34441	TR41	30	35321	T34	39	35690	T90	28
30110		43	30234		32	32101	T1X	36	34442	TR42	30	35323	T35	39	35695	T95	28
30111		43	30236		33	32102	T2X	36	34543	TR43	30	35325	T36	39	35696	T96	28
30112		43	30237		33	32106	T6A	35	34545	TR44X	30	35327	T11D	38	35697	T95A	28
30113		43	30238		33	32109	T9A	35	34547	TR44SW	30	35329	T11E	38	35795	TM95	28
30114		43	30239		33	32110	T9C	35	34644	T45A-2000K	37	35331	TG331	38	35805	D105A	45
30115		43	30240		33	32115	T5	35	34645	T45A	37	35332	TG332	38	35847	T147A	45
30116		43	30352		42	32116	T16A	35	34647	T45HD	37	35333	TG333	38	35924	T24B	34
30120		42	30356		42	32117	T16C	35	34648	T48A	35	35334	TG334	38	35926	T26B	34
30121		42	30362		42	32118	T8	35	34652	T52	33	35335	T335	38	35998	T98	34
30149		42	30366		42	32119	T19	36	34670	T100	33	35336	T336	38	35999	T99B	34
30150		42	30511	B111	45	32120	T20	36	34672	TS72	41	35337	TG337	38	36001	T101	40
30156		42	30515	T15	44	32121	T21R	36	34674	TS74	41	35354	B230	44	36002	T102	40
30158		42	30605		43	32123	T23	34	34678	TS42	41	35355	B232	44	36003	T103	40
30161		42	30606		42	32125	T25	34	34746	T46	36	35411	TG11B	39	36004	T104	40
30165		30	30609	TX9	31	32126	T26A	34	34747	T46A	36	35413	TG11R	39	36005	T105	40
30170		42	30610	TX10	31	32127	T27	34	34748	T46B	36	35417	TG33R	39	36006	T106	40
30174		32	30612	TX12	31	32128	T27A	35	34749	T46C	36	35421	TG334	39	36007	T101A	40
30175		32	30618	TX200	31	32318	TR5	29	34846	T47	36	35423	TG35	39	36015	T115	40
30176		32	30619	TX241	31	32501	TR1	29	34847	T47A	36, 37	35425	TG36	39	37003	80H-3	38
30179		32	30620	TX50	31	32502	TR2	29	34848	T47B	36	35427	TG11E	38	37004	80H-4	38
30181		33	31360	B260	44	32503	TR3	29	34849	T47C	36	35429	TG11E	38	37103	85H-3	38
30182		33	31360-01	B261	44	32505	TR3A	29	34945	T45SX	35	35446		27	37113	85G-3	38
30183		33	31360-99	B262	44	32506	TR3X	29	34946	T45DX	35	35447	T2005	26, 27	37302	84H-2	38
30184		33	31432	T132	42	32508	TR98	29	35104	T11RH	39	35448	T2006	27	37304	84H-4	38
30185		33	31433	T133	42	32509	TR9	29	35105	T34RH	39	35449	T2001	24, 25	37308	84H-8	38
30186		33	31437		42	32551	TRM1	29	35110		38	35450	T2002	24, 25	37310	84H-10	38
30187		33	31438		42	32552	TRM2	29	35111	T11BH	39	35453	T100K	25	37312	84H-12	38
30188		33	31439		42	32553	TRM3	29	35113	T11HN	39	35460	T11K	38	37316	84H-16	38
30189		33	31440		41	32556	TRM6	29	35119	T11CH	39	35529	T11AH	39	37320	84H-20	38
30195		33	31446		42	32557	TRM7	29	35127	T11DH	39	35595	TC95	28	38600	T600	41
30196		33	31551	T51	44	32610		29	35129	T11EH	39	35620	T9520	28	38601	T601	41
30197		33	31553	T53	44	33219	T19A	36	35201	T12B	39	35630		46	38620		41
30198		33	31554	T54	44	33220	T20A	36	35202	T12D	39	35633		46	39730		45
30199		33	31564		31	33223	T23A	34	35206	TG31H	39	35634		46	39805	T43A	35
30200		33	31565	T65	31	33224	T23B	34	35211	TG11BH	39	35635		46	39806	T43C	36
30201		33	31566	T66	31	33238	T38	36	35219	TG11CH	39	35637		46	39808	T44	36
30202		33	31567	T67	31	33239	T39	36	35227	TG11DH	39	35638		46	39810	T43D	36
30203		33	31568	T68	31	33341	T41	33	35229	TG11EH	39	35656	T56	28			
30204		33	31710		25, 27, 37	33342	T42	33	35230	T11KH	39	35657	T57	28			

KEN-TOOL®
MODEL NO. - PG. NO.

MODEL NO.	EDP NO.	PG. NO.	MODEL NO.	EDP NO.	PG. NO.	MODEL NO.	EDP NO.	PG. NO.	MODEL NO.	EDP NO.	PG. NO.	MODEL NO.	EDP NO.	PG. NO.	MODEL NO.	EDP NO.	PG. NO.
80H-3	37003	38	T11CH	35119	39	T32	35310	38	T56	35656	28	T2001	35449	24, 25	TR10	34401	29
80H-4	37004	38	T11D	35327	38	T33R	35317	39	T57	35657	28	T2002	35450	24, 25	TR11	34402	29
84H-2	37302	38	T11DH	35127	39	T34	35321	39	T59	35659	28	T2005	35447	26, 27	TR41	34441	30
84H-4	37304	38	T11E	35329	38	T34RH	35105	39	T61	35661	28	T2006	35448	27	TR42	34442	30
84H-8	37308	38	T11EH	35129	39	T35	35323	39	T62	35662	28	T9520	35620	28	TR43	34543	30
84H-10	37310	38	T11HN	35113	39	T36	35325	39	T63	35663	28	TC95	35595	28	TR44SW	34547	30
84H-12	37312	38	T11K	35460	38	T38	33238	36	T65	31565	31	TG11B	35411	39	TR44X	34545	30
84H-16	37316	38	T11KH	35230	39	T39	33239	36	T66	31566	31	TG11BH	35211	39	TR98	32508	29
84H-20	37320	38	T11R	35313	39	T41	33341	33	T67	31567	31	TG11CH	35219	39	TRM1	32551	29
85G-3	37113	38	T11RH	35104	39	T42	33342	33	T68	31568	31	TG11D	35427	38	TRM2	32552	29
85H-3	37103	38	T12B	35201	39	T43A	39805	35	T90	35690	28	TG11DH	35227	39	TRM3	32553	29
B36	32036	45	T12D	35202	39	T43C	39806	36	T95	35695	28	TG11E	35429	38	TRM6	32556	29
B37	32037	45	T15	30515	44	T43D	39810	36	T95A	35697	28	TG11EH	35229	39	TRM7	32557	29
B39	32039	45	T16A	32116	35	T44	39808	36	T96	35696	28	TG11R	35413	39	TS42	34678	41
B40	32040	45	T16C	32117	35	T45A	34645	37	T98	35998	34	TG31H	35206	39	TS72	34672	41
B111	30511	45	T16P	30215	45	T45A-2000K	34644	37	T99B	35999	34	TG33R	35417	39	TS74	34678	41
B230	35354	44	T19	32119	36	T45HD	34647	37	T100	34670	33	TG34	35421	39	TX9	30609	31
B232	35355	44	T19A	33219	36	T45DX	34946	35	T101	36001	40	TG35	35423	39	TX10	30610	31
B260	31360	44	T20	32120	36	T45SX	34945	35	T101A	36007	40	TG36	35425	39	TX12	30612	31
B261	31360-01	44	T20A	33220	36	T46	34746	36	T102	36002	40	TG331	35331	38	TX50	30620	31
B262	31360-99	44	T21F	34121	36	T46A	34747	36	T103	36003	40	TG332	35332	38	TX200	30618	31
D105A	35805	45	T21HD	34122	36	T46B	34748	36	T104	36004	40	TG333	35333	38	TX241	30619	31
T1X	32101	36	T23A	33223	34	T46C	34749	36	T105	36005	40	TG334	35334	38			
T2X	32102	36	T23B	33224	34	T47	34846	36	T106	36006	40	TG337	35337	38			
T5	32115	35	T21R	32121	36	T47A	34847	36, 37	T115	36015	40	TM95	35795	28			
T8	32118	35	T23	32123	34	T47B	34848	36	T132	31432	42	TR1	32501	29			
T6A	32106	35	T24B	35924	34	T47C	34849	36	T133	31433	42	TR2	32502	29			
T9A	32109	35	T26B	35926	34	T48A	34648	35	T147A	35847	45	TR3	32503	29			
T9C	32110	35	T25	32125	34	T51	31551	44	T335	35335	38	TR3A	32505	29			
T11AH	35529	39	T26A	32126	34	T52	34652	33	T336	35336	38	TR3X	32506	29			
T11B	35311	39	T27	32127	34	T53	31553	44	T600	38600	41	TR5	32318	29			
T11BH	35111	39	T27A	32128	35	T54	31554	33	T601	38601	41	TR9	32509	29			

Catalog Quick Help

Click on any item in the Index to jump to that item in the catalog.

Click on any Model, EDP or Page Number in the Cross Reference to jump to that page.

Click on any "See Page XX" reference to jump to that page.

Click on the page numbers in the bottom corners to open a "Jump to page" dialog.

Click on the Grey bars on the left or right sides of the page to jump to the Index.

Use the "Home" "End" "Page Up" "Page Down" and Arrow Keys to navigate.

Distributed By:



768 E. North Street, P.O. Box 9320
Akron, Ohio 44305

Phone: 330-535-7177 • Fax: 330-535-1345

E-mail: sales@kentool.com

www.kentool.com

www.oldforge.com www.caricatools.com